

GE Infrastructure
Sensing

Druck DBC 150/650 Series

Dry block temperature calibrator

User manual - K400

[EN]	English	1 56
[FR]	French	TBA
[DE]	German	TBA
[IT]	Italian	TBA
[PT]	Portuguese	TBA
[ES]	Spanish	TBA



© 2005 General Electric Company. All rights reserved.

Introduction

- This technical manual provides operating instructions for the Druck DBC Series of Dry Well Calibrators.

Safety

- The manufacturer has designed this equipment to be safe when operated using the procedures detailed in this manual. Do not use this equipment for any other purpose than that stated.
- This publication contains operating and safety instructions that must be followed to ensure safe operation and to maintain the equipment in a safe condition. The safety instructions are either warnings or cautions issued to protect the user and the equipment from injury or damage.
- Use suitably qualified * technicians and good engineering practice for all procedures in this publication.

Test leads

- Only use the test leads supplied with the instrument, do not use these test leads with any other equipment.

Power isolation

- Access to the power supply isolator switch must not be obstructed.

Toxic Materials

- There are no known toxic materials used in construction of this equipment.

Maintenance

- The equipment must be maintained using the procedures in this publication. Further manufacturer's procedures should be carried out by authorized service agents or the manufacturer's service departments.

Technical Advice

- For technical advice contact the manufacturer.

**A qualified technician must have the necessary technical knowledge, documentation, special test equipment and tools to carry out the required work on this equipment.*



This equipment meets the requirements of all relevant European safety directives. The equipment carries the CE mark.

TRACEABILITY AND CALIBRATION REPORT

- Each DBC instrument is supplied as standard with a calibration report, declaring traceability to a National or International standard.

WARRANTY AND LIABILITY

- 1 Our equipment is guaranteed against defective material and workmanship during the warranty period. Claims under warranty can be made by returning the equipment, prepaid, to our factory. The equipment will be replaced, repaired or adjusted at our discretion.
- 2 The liability of GE is restricted to that given under our warranty. No responsibility is accepted for damage, loss or other expense incurred through the sale or use of our equipment.
- 3 Under no circumstances will GE be liable for any special incidental or consequential damage.

Symbols

The following symbols are used to identify hazards on the instrument:



This symbol, on the instrument, indicates that the user should refer to the user manual.



This symbol, on the instrument, indicates a very hot surface that must not be touched.

Safety Instructions

This instrument should only be used by suitably qualified * technicians

During operation observe the following safety instructions:

- 1 **USE** the instrument in vertical position only.
- 2 **DO NOT** place any object on the protection grid of the dry well.
- 3 **DO NOT** put any liquid into the dry well and/or on the inserts.
- 4 **DO NOT** use fluids to clean the dry well and/or the inserts.
- 5 **BEFORE** any maintenance activity, **WAIT** for the instrument to cool to ambient temperature (keep the instrument switched on, to allow the cooling fan to operate).
- 6 **DO NOT** touch the protection grid until it has cooled to ambient temperature).
- 7 The instrument must be at ambient temperature before storing in any transit case or packing system.
- 8 **DO NOT** use this instrument near inflammable liquids or in Hazardous areas.
- 9 **DO NOT** place either your hands, or any other object, into the dry well.
- 10 Before use, **REMOVE** all traces of contamination from the device under test.
- 11 During normal operation, this instrument could reach high temperatures.
- 12 Always observe all the safety instructions.

**A qualified technician must have the necessary technical knowledge, documentation, special test equipment and tools to carry out the required work on this equipment.*

Abbreviations

The following abbreviations are used in this manual; the abbreviations are the same in the singular and plural.

BLK	block	ent	enter
CJ	Cold Junction	CJC	Cold Junction Compensation
DBC	Dry Block Calibrator	°C	Degrees Centigrade
in	inch	mA	milliampere
mm	millimetre	mV	millivolt
RDG	reading	RTD	Resistive Temperature Device
T/C	Thermocouple	V	Volt
TC	Temperature Calibrator	TS	Temperature Source

TABLE OF CONTENTS

Introduction	i
Safety	i
Traceability and Calibration Report.....	ii
Symbols	ii
Safety Instructions.....	iii
Index	iv
Standard and optional accessories.....	vii
1 INTRODUCTION	1
1.1 Automatic calibration	2
1.2 Parts identification	2
2 INSTALLATION	4
2.1 Preparation	4
2.2 Power Supply.....	4
2.3 Temperature Probes.....	4
2.4 Electrical Connections.....	6
3 OPERATION	11
3.1 Key-pad Functions.....	11
3.2 Operating Displays.....	13
Menu selection screen.....	13
System Set-up screen.....	13
Working screen.....	13
Help/Info screen.....	14
Self-test screen.....	14
3.3 Functional Modes.....	15
Reading of the generated temperature.....	15
Dual display - (generated temperature and an input test)..	15
3.4 Temperature Reference Selection.....	16
Internal reference probe.....	16
External reference probe.....	16
3.5 System Set-up	18
Language settings.....	18
Temperature unit settings.....	18
Key-pad audio signal.....	19
Digital Interface settings.....	19

	Printer settings.....	20
	Calibration.....	20
	Protection code.....	21
3.6	Testing Modes.....	22
	Direct mode.....	22
	Step mode.....	23
	Fixed step selection.....	23
	Programmable step selection.....	24
	Ramp mode.....	25
	Preset values mode.....	26
3.7	Measuring an Input.....	27
	Switch test.....	27
	Thermocouple testing.....	28
	Internal.....	29
	Setting Cold Junction Compensation.....	29
	Direct.....	30
	CAL mode.....	30
	Absolute.....	31
	% of span.....	31
	% of reading.....	32
	RTD measurements.....	33
	Direct.....	34
	CAL mode.....	34
	Absolute.....	35
	% of span.....	35
	% of reading.....	36
	Current measurements.....	37
	Direct.....	37
	CAL.....	38
	Voltage measurements (high level).....	39
	Direct.....	39
	CAL.....	40
	Voltage measurements (low level).....	41
	Resistance measurements.....	42
4	SERIAL COMMUNICATION	43

4.1	DBC Series - Serial Commands Protocol.....	43
5	CALIBRATION	48
	Calibration of the Standard Reference Probe Input.....	48
	Calibration of the External Reference Probe	49
	Calibration of the Internal Dry Well Sensor.....	49
	Calibration of the Millivolt Input Range	50
	Calibration of the Volt Input Range	51
	Calibration of the mA Input Range	51
	Calibration of the Ohm Input Range	52
6	FAULT FINDING	53
7	MAINTENANCE	54
7.1	Cleaning Instructions.....	54
8	TECHNICAL SPECIFICATION	55
8.1	Standard Specification.....	55
8.2	Common Specification.....	55
8.3	Electrical Input Specification (DBC-TC models).....	56

STANDARD ACCESSORIES DBC-TC series

The DBC-TC series is supplied with the following standard accessories:

- Operating manual
- Set of leads for:
 - 2 test leads and 2 clamps for switch connection
 - 6 test leads and 6 clamps for connection of electrical signal
- Power supply cable
- Removable insert with 3 holes (5, 6.6, 9.8 mm diameter), (3/16, 1/4, 3/8 in. diameter for USA)
- Tool for extraction of removable insert
- RS232 interface cable (1.5 metre, 5 pin/5 pin)
- Traceable calibration certificate
- 2 spare fuses (see page 4 for more information)

OPTIONAL ACCESSORIES DBC-TC series

- Option B1 for DBC 150, reference probe type PT 100, range -50°C to $+400^{\circ}\text{C}$
- Option B2 for DBC 650, reference probe type PT 100, range $+50^{\circ}\text{C}$ to $+650^{\circ}\text{C}$
- Option B3, temperature probe type PT 100, range -50°C to $+650^{\circ}\text{C}$.
- Option D, fast cooling device
- Option E, aluminium transit case
- Option C1/C2, insert with 2 holes (5 and 13 mm diameter), (3/16, 1/2 in. diameter for USA)
- Option C3/C4, insert with 4 holes (3.4, 5, 5, 8.2 mm diameter), (1/8, 3/16, 3/16 and 5/16 in. diameter for USA)
- Option C5/C6, blank insert
- Option C7/C8, insert with special holes.

STANDARD ACCESSORIES DBC-TS series

The DBC-TC series is supplied with the following standard accessories:

- Operating manual
- Set of leads for:
 - 2 test leads and 2 clamps for switch connection
- Power supply cable
- Removable insert with 3 holes (5, 6.6, 9.8 mm diameter), (3/16, 1/4, 3/8 in. diameter for USA)
- Tool for extraction of removable insert
- RS232 interface cable (1.5 metre, 5 pin/5 pin)
- Traceable calibration certificate
- 2 spare fuses (see page 4 for more information)

OPTIONAL ACCESSORIES DBC-TS series

- Option B1 for DBC 150, reference probe type PT 100, range -50°C to $+400^{\circ}\text{C}$
- Option B2 for DBC 650, reference probe type PT 100, range $+50^{\circ}\text{C}$ to $+650^{\circ}\text{C}$
- Option B3, temperature probe type PT 100, range -50°C to $+650^{\circ}\text{C}$.
- Option D, fast cooling device
- Option E, aluminium transit case
- Option C1/C2, insert with 2 holes (5 and 13 mm diameter), (3/16, 1/2 in. diameter for USA)
- Option C3/C4, insert with 4 holes (3.4, 5, 5, 8.2 mm diameter), (1/8, 3/16, 3/16 and 5/16 in. diameter for USA)
- Option C5/C6, blank insert
- Option C7/C8, insert with special holes.

1 INTRODUCTION

The DBC series of temperature calibrators test and calibrate temperature devices. The series comprises two types: a TS (Temperature Source) and a TC (Temperature Calibrator). Multilingual firmware provides a menu-driven user interface in English, French, German, Italian, Spanish and Portuguese. An RS232 digital interface, supplied as standard, enables remote operation of the instrument from a compatible computer.

TS (Temperature Source)

The DBC-TS generates stable temperatures and accurately measures the temperature of the dry well. It provides an automatic switch test facility. There are two models of the DBC-TS, providing the same operating capabilities at different temperature ranges:

- DBC 150-TS : -45°C below ambient temperature to +150°C.
- DBC 650-TS : +50°C to +650°C.

This series of calibrators uses the GE technology temperature controller, providing high performance temperature stability and accuracy. Temperature generation can be controlled either in manual mode (direct) or automatic with ramping, stepping or preset functions. The dry well temperature can be measured either with the internal probe or with an external certified reference probe. The key-pad, display and electrical connections enable the user to carry out test procedures for RTD and thermal switches with a hysteresis calculation.

TC (Temperature Calibrator)

The DBC-TC generates stable temperatures and accurately measures the temperature of the dry well. It measures process signals from the temperature devices under test.

There are two models of this series, providing the same operating capabilities at different temperature ranges:

- DBC 150-TC : -45°C below ambient temperature to +150°C.
- DBC 650-TC : +50°C to +650°C.

This series of calibrators uses the GE technology temperature controller, providing high performance temperature stability and accuracy. Temperature generation can be controlled either in manual mode (direct) or automatic with ramping, stepping or preset functions. The dry well temperature can be measured either with the internal probe or with an external certified reference probe.

The key-pad, display and electrical connections enable the user to carry out test procedures for thermocouples, RTD, switches, temperature transmitters and converters, regulators. Both TC models contain a switch test function with a hysteresis calculation. This Input/Measure facility enables direct connection and reading of thermocouples, RTD, Voltages, Current and Resistance: the dual display can simultaneously show the generated temperature (with internal or external

reference) and a possible electrical feedback from a device under test (i. e. temperature probes, temperature transmitters). An error calculation, with scaling function, allows the user to check immediately the accuracy specification of the unit under test. A 24 V auxiliary excitation provides power for temperature transmitters under test.

1.1 Automatic Calibration

An RS232 computer interface enables a Calibration Management Software to provide automatic calibration procedures, typically with the following capabilities:

- Creation of instrument details
- Creation of test procedures and work orders
- Analysis of devices due for calibration
- Printing of calibration reports
- Export functions

Refer to section 4 SERIAL COMMUNICATION for remote control of this instrument.

1.2 Parts Identification

Key to Figure 1-1

Fig no.	Description
1	Dry well with insert
2	Protection grid
3	Carrying handle
4	4 mm socket for T/C, RTD and ohm connection, with CJ compensation
5	tactile key-pad for direct selection of all the operating function (ramps, steps, preset values, switch test, help, set-up) and to set temperature values
6	Cooling fan
7	Support feet (4)
8	Protection fuse (115 Vac 2x12.5 AT and 230 Vac 2x6.3 AT for DBC 650 (115 Vac 2x1.6 AT and 230 Vac 2x3.15 AT for DBC 150)
9	Main power selector 100 - 120 Vac and 220 - 240 Vac, 50/60 Hz
10	Power supply on/off switch
11	Main power socket: to connect the standard power cable
12	RS232 serial communications interface
13	Cursor (arrow) keys to select operating functions from the main menu and to move the selection cursor through the menus
14	Digital display with Multi-language user interface
15	Switch test connection, suitable to connect test leads supplied as standard
16	4 mm socket for voltage and current input with 24V dc auxiliary excitation
17	Lemo connection for external reference probe: suitable for connecting PT 100 probes with 3 or 4 wires, supplied with standard mating connector (B1, B2 and B3 options)

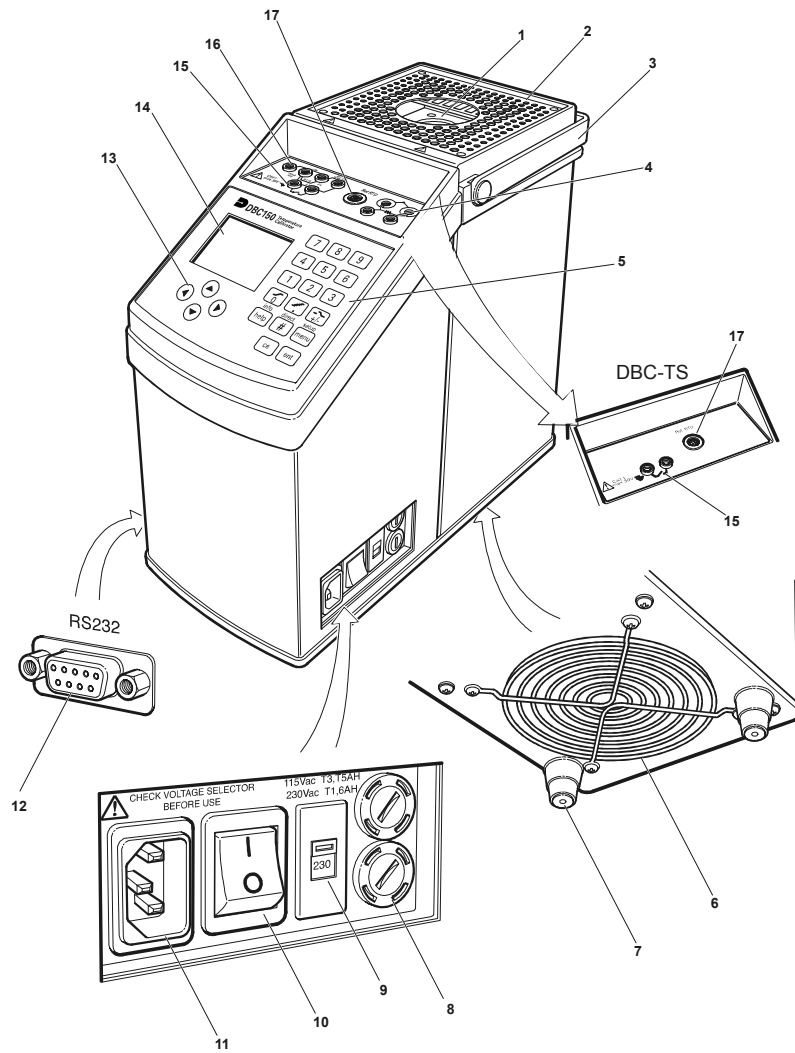

Figure 1-1

2 INSTALLATION

2.1 Preparation

General

- Remove the instrument from the carrying case and use it on a flat, stable surface. To avoid any possible damage, either to the instrument or the unit under test, the dry well of the instrument must be used in the vertical position.
- The fan system at the base of the instrument must be free from any obstruction.
- The dry well must be completely clean.
- Carefully read the SAFETY section of this manual.

2.2 Power Supply

CAUTION:

BEFORE OPERATING, CHECK THAT THE POWER SUPPLY SELECTOR SWITCH SETTING MATCHES THE POWER SUPPLY VOLTAGE.

The DBC series of calibrators operate from an a. c. power supply of 100 to 120 Vac or 220 to 240 Vac, 50-60 Hz.

CAUTIONS:

- 1 THE POWER SUPPLY MUST PROVIDE CONNECTION TO A PROTECTIVE GROUND TERMINAL.
- 2 THE INSTRUMENT MUST, AT ALL TIMES, BE CONNECTED TO THE SUPPLY EARTH (GROUND).

2.3 Temperature Probes

WARNING

AFTER USE, THE PROBES WILL BE VERY HOT. HANDLE WITH CARE AND WAIT FOR THE PROBES TO COOL COMPLETELY.

The temperature probe to be tested must be correctly placed in the dry well to produce accurate test results:

- Check the probe diameter and operating range and use reduction inserts with the correct sized holes (the hole diameter should comply with EA-10/13 guidelines). A large temperature difference between probe and dry well causes large measuring errors. This difference increases as the difference between the diameters increases.
- Always clean the probes, before use.
- Do not force the probes into the dry well, insert the probe down to the bottom of the dry well.

- When testing a probe with a certified reference probe, place both probes close together and at the same depth.

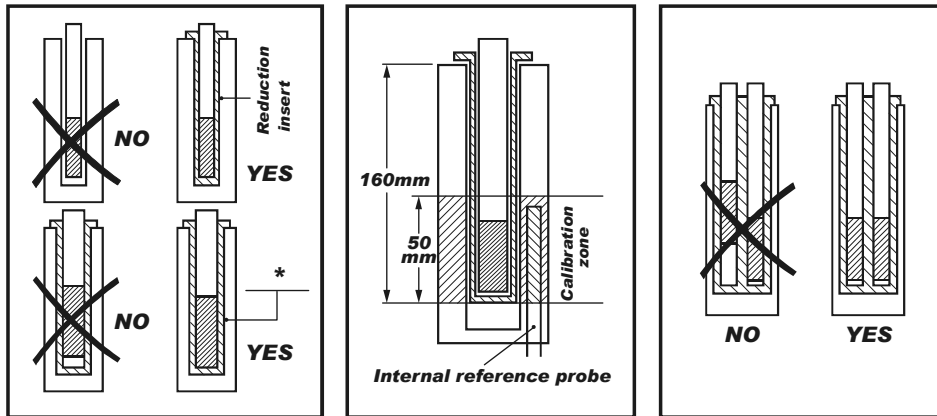

* dimension should comply with EA-10/13 guidelines - for temperature ranges -80°C to $+660^{\circ}\text{C}$ maximum 0.5mm

IMPORTANT NOTE

Reduction inserts with special holes could be necessary when carrying out a calibration procedure on temperature device with specific mechanical dimensions. Refer to GE for details of specific application solutions.

2.4 Electrical Connections

- Connection of a Thermocouple sensor

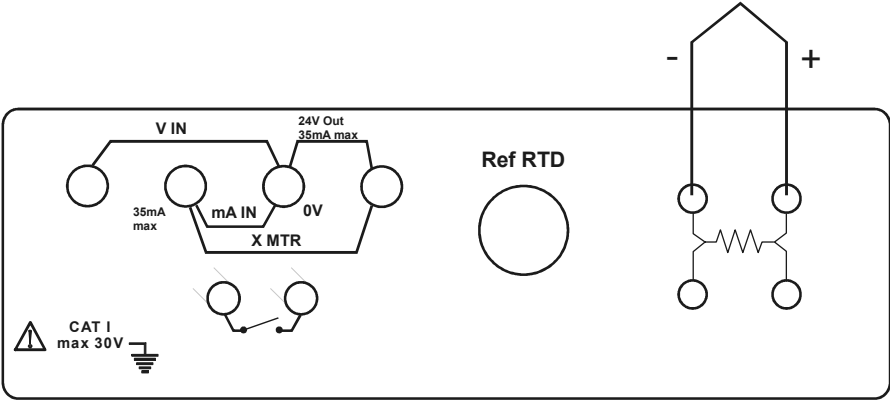

- Use of screw connections for T/C wires

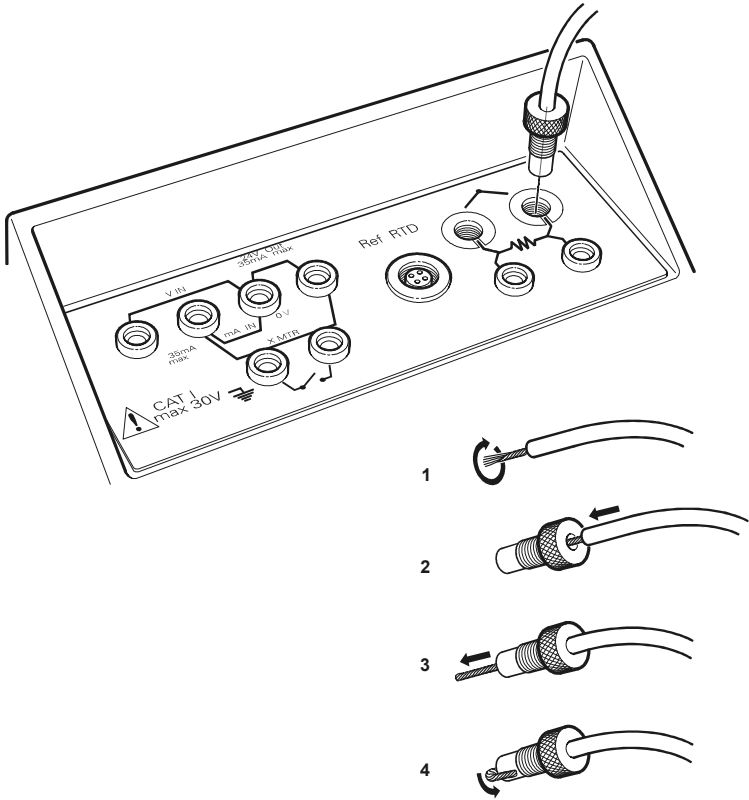

- Connection of a 3-wire RTD.

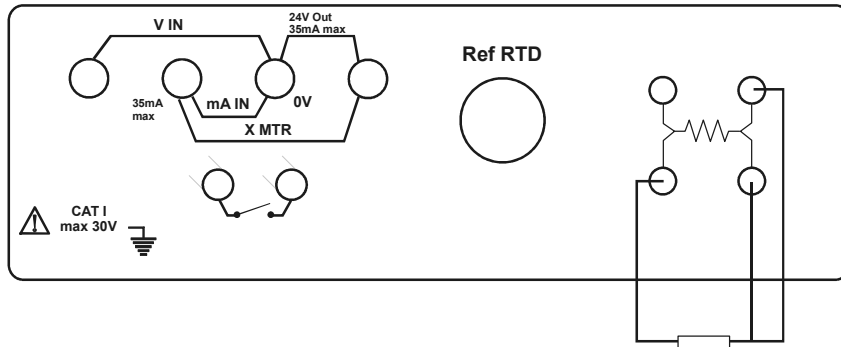

- Connection of a 4-wire RTD

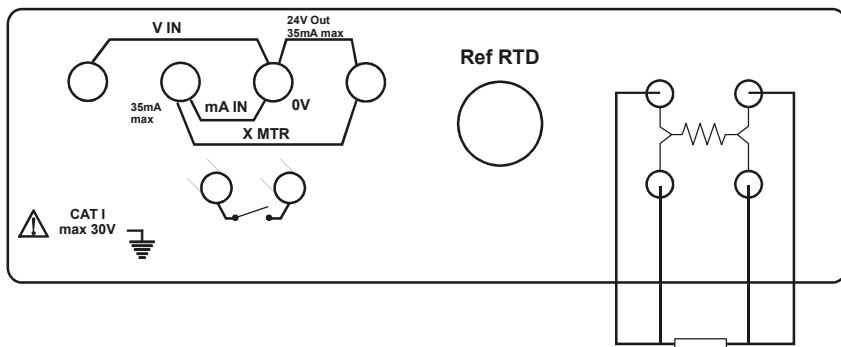

- Connection of a 2-wire T/I transmitter (external 24 V dc excitation)

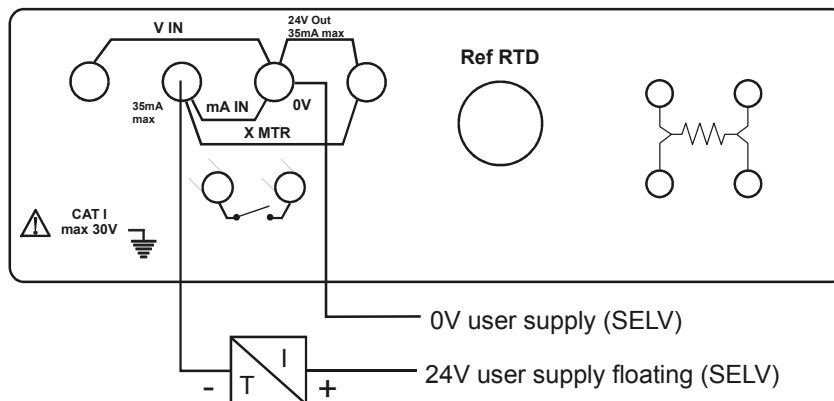

- Connection of a 2-wire T/I transmitter (with 24 V dc auxiliary excitation)

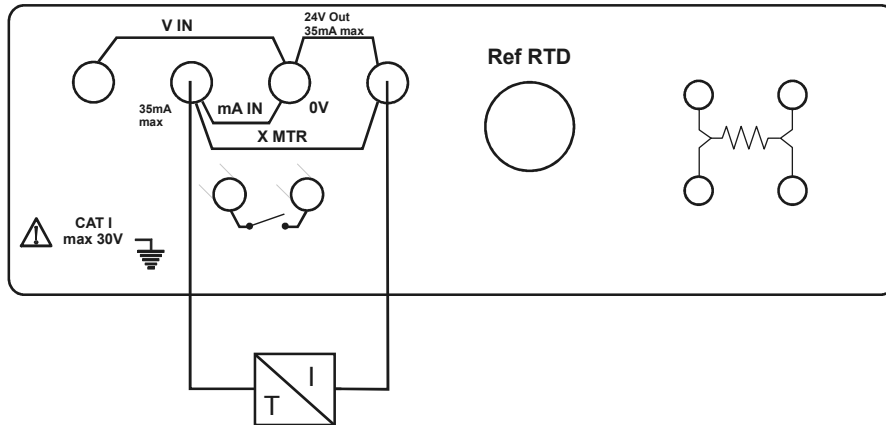

- General

The temperature probes to be tested fit into an appropriate size reduction insert located in the 30 mm diameter hole of the dry well. The dry well can be heated by either cartridge heaters (DBC 650) or Peltier cells (DBC 150). A fan system fitted on the bottom of the instrument reduces the temperature during cooling operations.

Operating procedure

The DBC Series can be used to carry out comparison test using a variety of methods:

Reading of temperature calibration with the internal regulation probe

The generated temperature is considered as reference value and is shown on the DBC display; this temperature is measured with the standard internal probe.

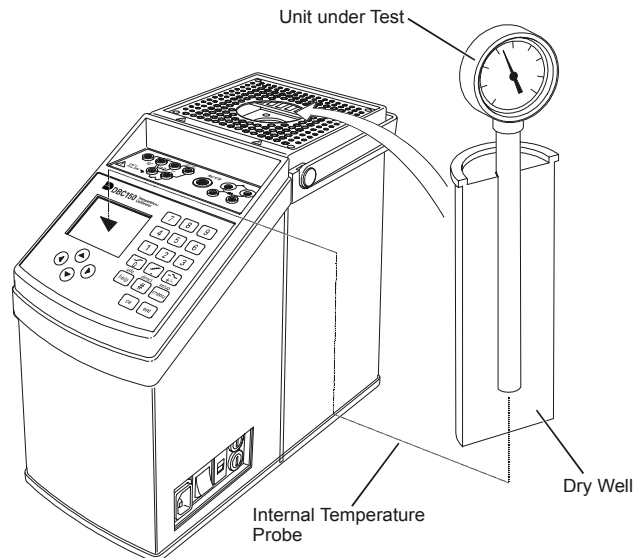

Calibration with external reference probe

The temperature value to be considered as standard is measured with an external and certified reference probe. This measurement reading can be directly shown either on the DBC display (connecting the reference probe to the REF RTD socket on the top of the instrument) or with an external, certified electronic calibrator.

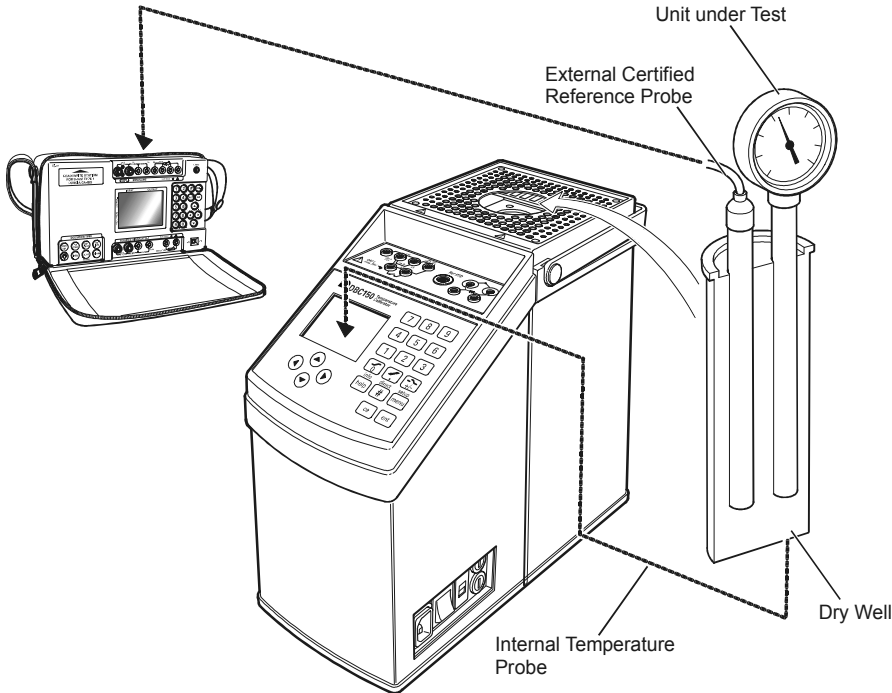

Power, reading and calibration of devices under test (DBC-TC only)

The DBC-TC series has the input capability to directly measure the electrical signal of unit under test (T/C, RTD, mA, V, Ohms): using an error calculation function (with scaling capability), calibration procedures can be carried out and the UUT accuracy immediately measured.

A 24 V auxiliary excitation supply is also available to power the loop of the device due for calibration. The generated temperature can be measured with the internal or the external reference as described above.

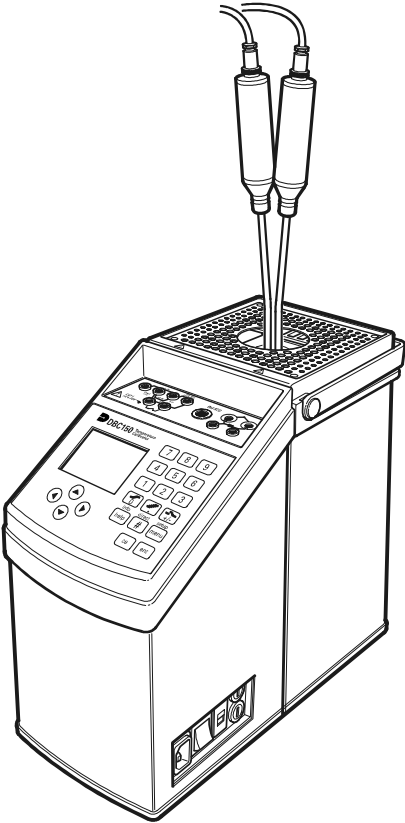

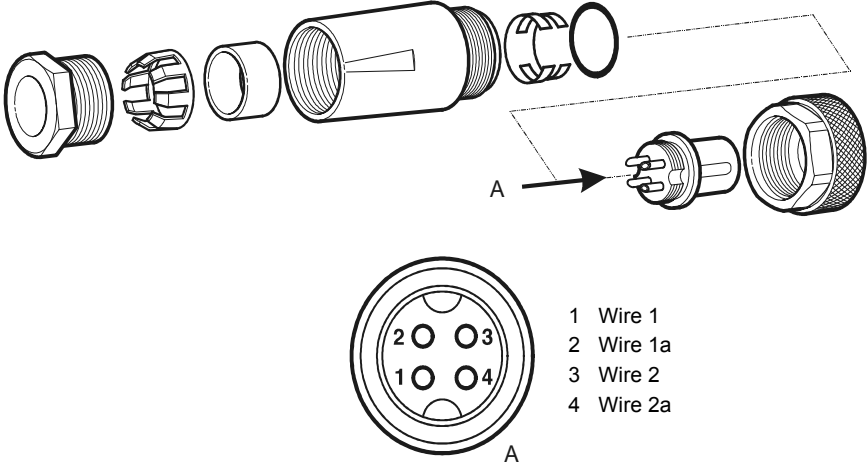

- **External probe connections**

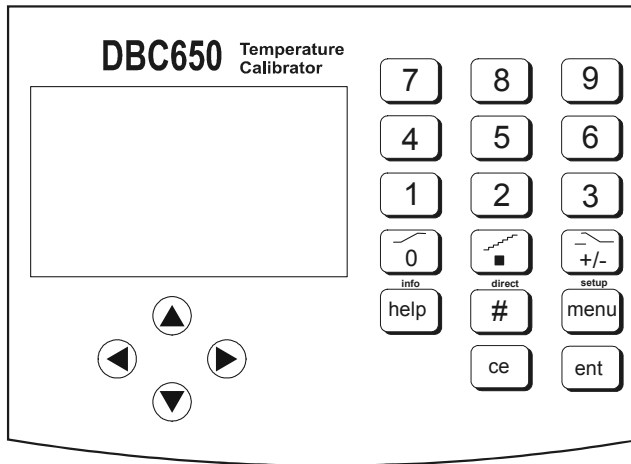

3 OPERATION

3.1 Key-pad Functions



- **ent (Enter) key**
 1. Pressing this key confirms the selected choices or the temperature set-point.
- **ce (clear entry) key**
 2. Pressing this key cancels the previous key operation or corrects a typing error.
- **menu/setup key**
 3. Pressing this key recalls the Menu Selection Screen. Pressing this key after the # key (2nd function), selects the SETUP menu display.
- **# key**
 4. Pressing this key selects DIRECT temperature generation mode. Pressing this key with other keys recalls second functions (# + set-up, # + , # +  etc.).
- **help/Info key**
 5. Pressing this key recalls a related display containing more information, either on the selected function or on the operation to be performed. Pressing this key after the # key, changes the display containing information relating to the selected temperature reference or to the selected test function (for example switch test).

- **+/- key**
- 6 Pressing this key changes the sign on working screen. Pressing this key after the # key, recalls the Switch Test function. Pressing # and +/- again to return to the working screen.
- **■ key**
- 7 Pressing this key sets the decimal point. Pressing this key after the # key, recalls the step generation mode, starting from the step selection screen.
- **0 key**
- 8 Pressing this key zeroes the display. Pressing this key after the # key, recalls the ramp generation mode, starting from the Ramp set-up screen.
- **1- 9 (numeric) keys**
- 9 Using these numeric keys sets a temperature value or a special generation mode (ramp limits, programmable steps etc.). Pressing keys 1- 5 after the # key, recalls specific preset values.
- **▲▼◀▶ (arrow) keys**
- 10 Pressing these keys moves the screen cursor either in the horizontal or vertical direction. When the ramp and step functions are enabled, these keys can start, stop, hold or recall related values.

3.2 OPERATING DISPLAYS

The DBC-TC series has four operating displays:

- **Menu selection screen**

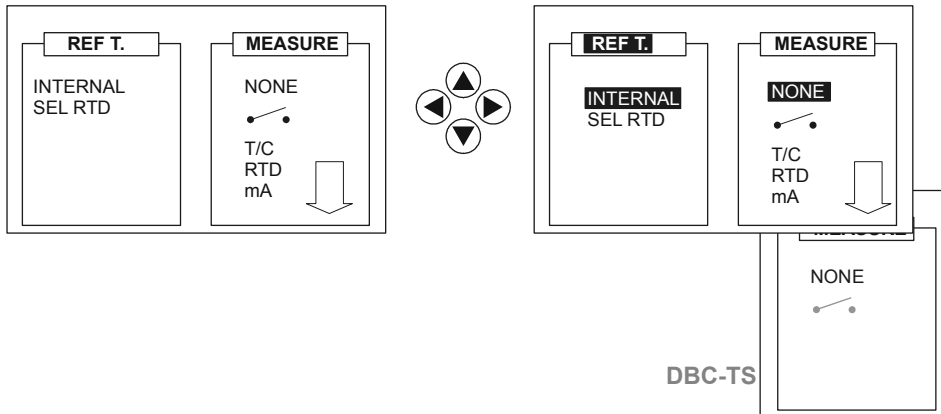

This display shows the measure parameters. The arrow keys move the cursor in both horizontal and vertical directions.

- **System Set-up Screen**

Press MENU to select the system set-up menu.

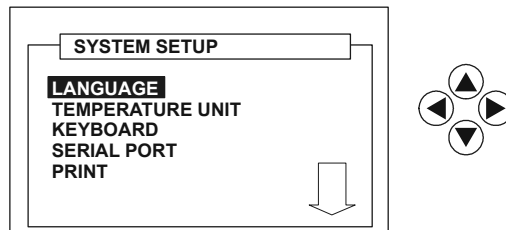

Use the \uparrow / \downarrow keys to move the cursor up/down and press **ent** to select.

- **Working screen**

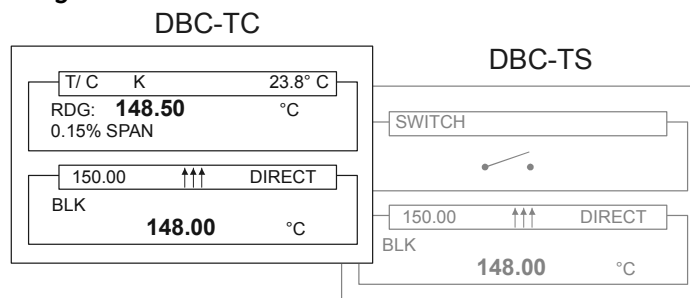

This display shows the temperature set-point, the actual temperature (with internal or external reference) and the current temperature measurement. Use the numeric key-pad to set the temperature value and, using the second function key, change the direct function to ramping, stepping and preset.

- **Help/Info screen**

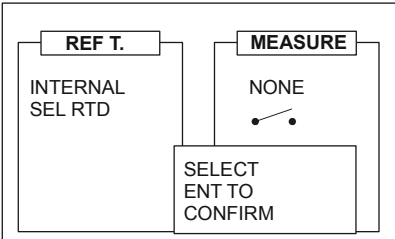

This display shows more information relating to the selected function or test/measure - (for example selected temperature reference – internal or external -, switch test, mA reading etc.).

- **Self-test screen**

Note:

When switched on, the display shows the self-test screen:

- Model
- Firmware release
- EPROM self-test
- Temperature regulator self-test

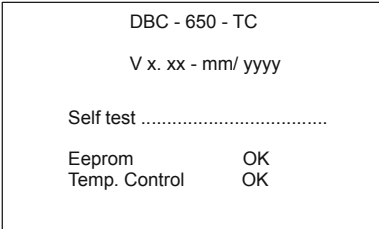

3.3 Function Modes

- Reading of the generated temperature

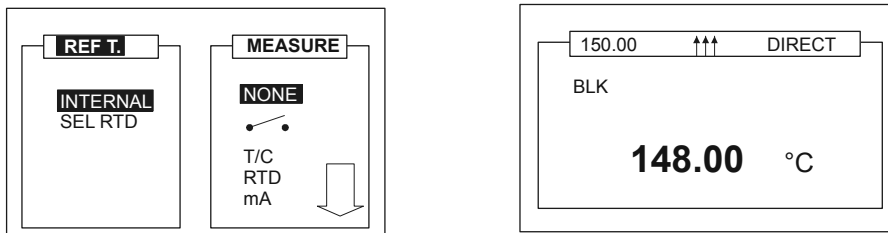

Press the **MENU** key to recall the Menu Selection Screen from any Working Screen. Leave the **MEASURE** (Input) display set to **NONE** to display the dry well (BLK) temperature with the temperature set-point shown in small numbers and arrow symbols indicating either a heating or cooling operation.

- Dual display – (generated temperature and an input (test) option)

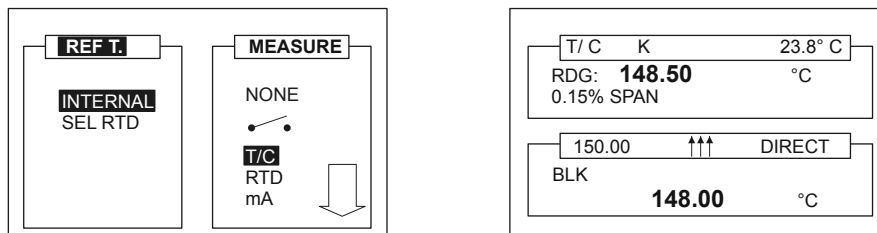

From the Menu Selection Screen, use the horizontal and vertical cursor keys move the cursor through the **REF. T** and **MEASURE** displays. Select both the reference for the temperature to be generated and an input option (measure). The final working screen, configured as a dual display, shows two sections of equal size, dry well temperature and the unit under test feedback (with or without scaling capability).

3.4 Temperature Reference Selection

The DBC series measures the dry well temperature in two different ways:

- **Internal reference probe**

From the standard working screen, press the menu key to open the menu selection screen:

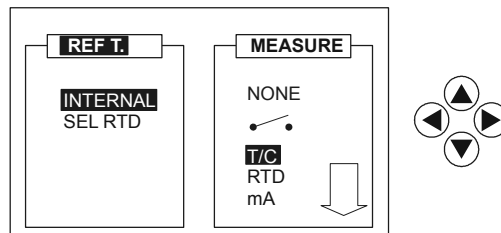

Using the keys, move the selection cursor on the **REF. T** display. Select **INTERNAL** with the keys and press **ent** to activate the dry well temperature measure made with the internal regulation probe. The next display allows the setting-up of the temperature generation mode (Direct, Ramp, Step or Preset).

- **External reference probe**

From the **REF. T** display of the Menu Selection Screen select the **SEL RTD** function using the keys and press **ent**.

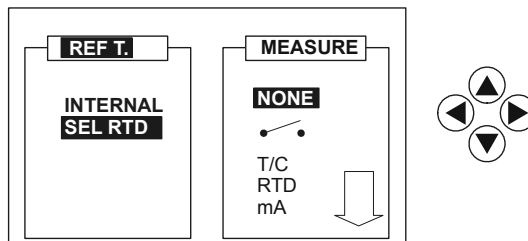

The next selection display now appears as follows.

Move the cursor with the ▲▼ keys, to select a REF 1 or REF 2 connection and press **ent**.

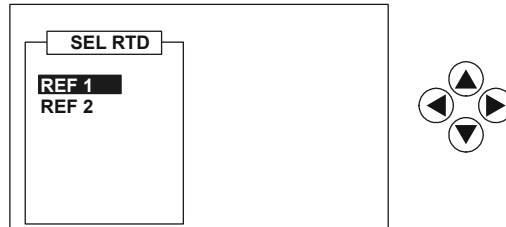

The following display allows the set-up of the temperature generation mode. Using this facility, the user can connect one of two certified probes to the Ref RTD connector and display the measured dry well temperature.

Note:

For best accuracy, use an optional reference probe (option B1, B2 or B3).

3.5 System Set-up

- **Language setting**

The DBC series have multi-lingual firmware with a default setting of English. To select a different language, press the **# + menu** keys to recall the System Set-up Screen. Using the **▲▼** keys select the required **LANGUAGE** (English, French, German, Italian, Portuguese or Spanish) and press **ent**. Press **ce** to return to the Working Screen.

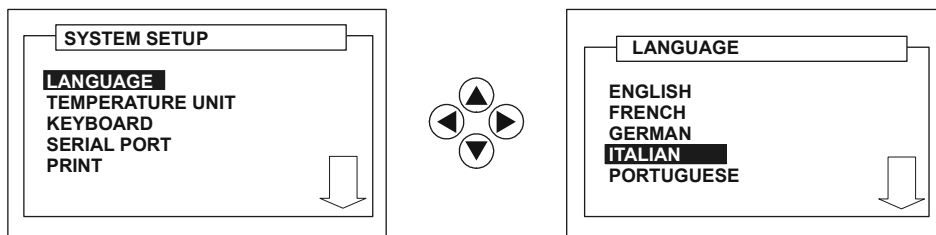

- **Temperature unit setting**

Press the **# + menu** keys to recall the System Set-up Screen, using the **▲▼** keys, select **TEMPERATURE UNIT** and press **ent**. Select the required temperature unit and press **ent** again. Press **ce** to leave the System Set-up Screen.

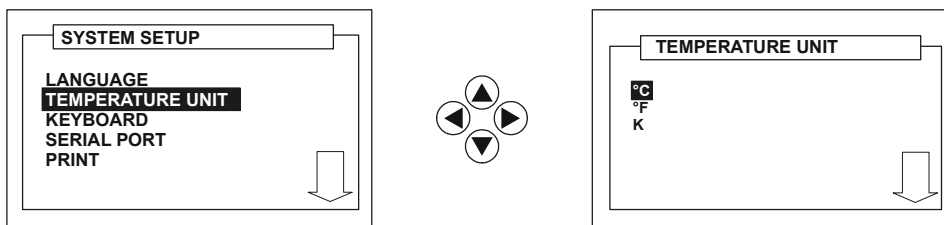

- **Key-pad audio signal**

The DBC series can give an audio signal to confirm each key press. To select this option, press the **# + menu** keys to recall the System Set-up Screen. Using the **▲▼** keys select **KEYBOARD** and press **ent**. Select the required function (beep off/on) and press **ent** again. Press **ce** to return to the Working Screen.

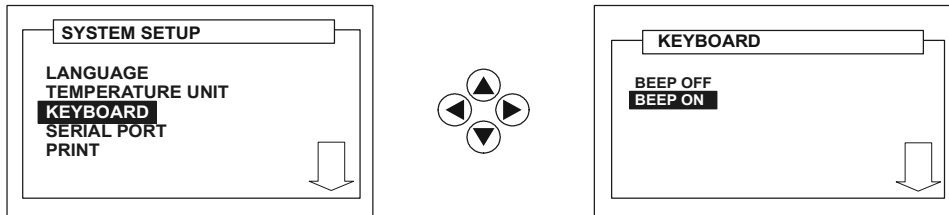

- **Digital interface settings**

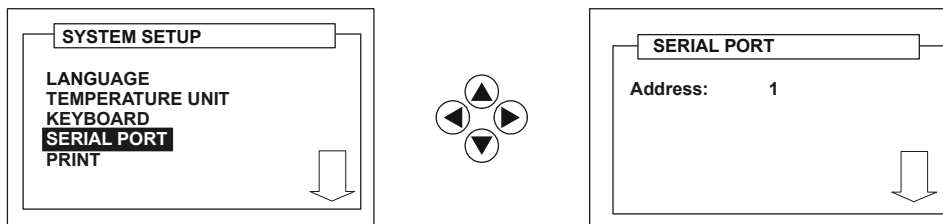

To set the RS232 communication address, select the System Set-up Screen, using the **▲▼** keys select **SERIAL PORT** and press **ent**. To set the communication address, use the numeric key-pad and press **ent**. Press **ce** twice to exit the System Set-up Screen.

- **Printer settings**

To print calibration data via the RS232 interface, press the **# + menu** keys to recall the System Set-up Screen. Using the **▲▼** keys, select **PRINT** and press **ent**. Select the parameter to be printed using the **▲▼** keys, (set-point temperature [SET], dry well temperature [BLK], reference temperature [REF], measure [RDG]). Use the numeric keys to set the period, in seconds, between each printout and press **ent**. Press **ce** to return to the Working Screen.

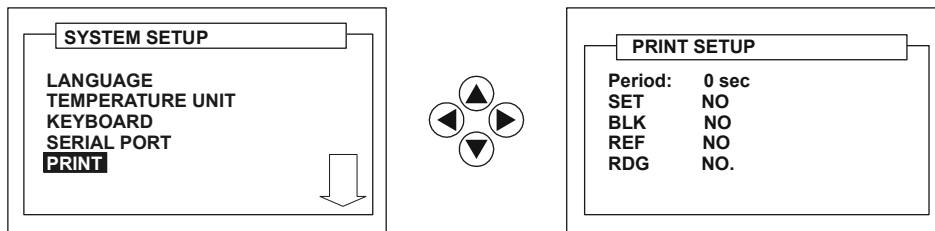

- **Calibration**

A PIN code protects the **CALIBRATION** function. Refer to 5 Calibration, page 47.

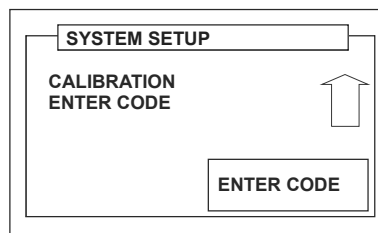

- **Protection code**

To set a new PIN code (initial code 4321) open the System Set-up Screen and, using the ▲▼ keys, select ENTER CODE and press **ent**. Using the numeric key-pad, enter the existing PIN (initial code 4321) and press **ent** to change the PIN code.

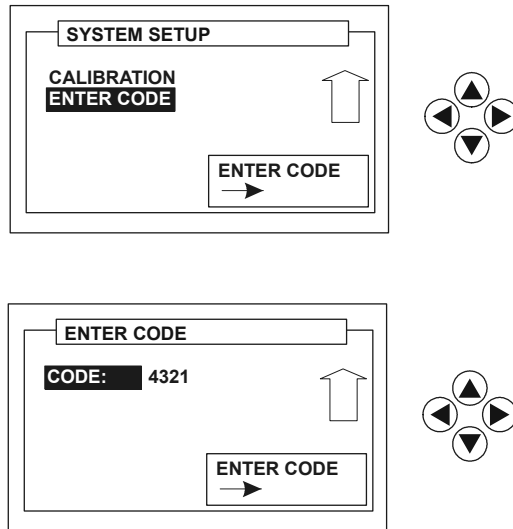

Note:

This procedure permanently changes the PIN code.

Using the numeric key-pad, set the new code and press **ent** to store it.

3.6 Testing Modes

- **Direct mode**

After switching on and self-test the display automatically changes to the **DIRECT** generation working screen. The related display shows the actual dry well temperature in large characters (from the internal or external probe), temperature set-point and a possible measurand (i.e. the last selections made).

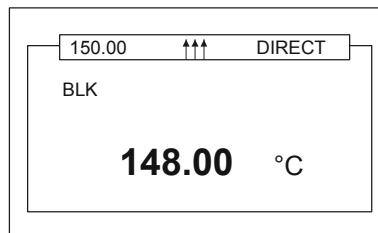

The status bar shows the temperature set-point, the ↑↑↑ symbol (indicating a cooling or heating condition) and the generation mode. To set a new set-point value and generate a new temperature, use the numeric key-pad and press **ent**. The calibrator immediately activates the temperature regulator and the status bar shows the new set-point, with the ↑↑↑ symbol indicating the new heating or cooling condition. On reaching the new set-point, the **RDY** (ready) message replaces the ↑↑↑ symbol.

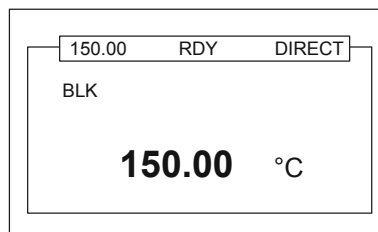

- **Step mode**

To set a **STEP** generation mode from the **DIRECT** mode display, press the **#** key (2nd function) and the **■** key. The display shows the step function selection menu as follows:

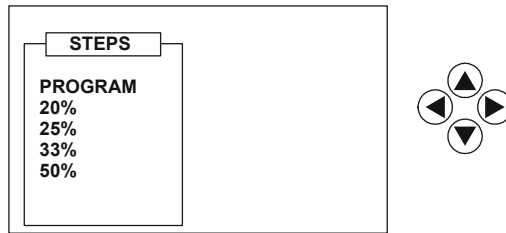

Using the \blacktriangle / \blacktriangledown keys, select the required percentage of temperature interval between each step or, depending on the application, program a variety of values.

- **Fixed step selection**

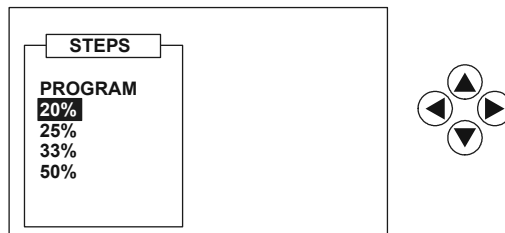

Using the \blacktriangle / \blacktriangledown keys, select one of the standard percentage steps (20, 25, 33, and 50%) and press **ent**. The following display allows the temperature range span to be set-up (e. g.), 0 to 100 %.

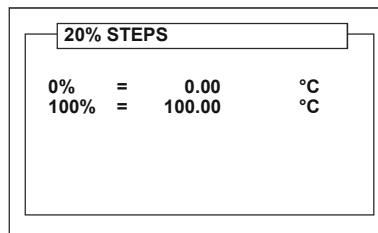

Using the \blacktriangle / \blacktriangledown keys, move the selection cursor in vertical direction, set the required temperature values (0 and 100 %) and press **ent**. In the next working screen, use the \blacktriangle / \blacktriangledown keys to increase or decrease the temperature set-point with the selected percentage difference between each step.

The status bar shows the recalled percentage step, together with the related temperature set-point, the step symbol () and the heating/cooling ↑↑↑↓ arrow symbols.

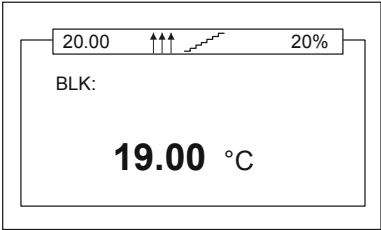

- Programmable step selection**
 From the display of step setting, select PROGRAM using the ▲▼ keys and press **ent**. The next display permits the temperature step size to be set-up (5 maximum).

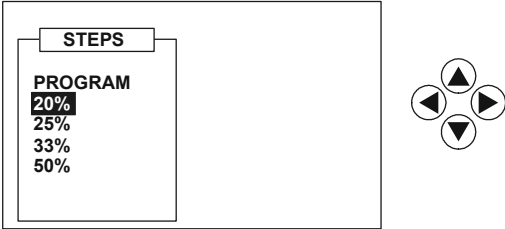

Using the ▲▼ keys select the number of step to be set and press **ent**. In the next display, move the selection cursor using the ▲▼ again and set a specific temperature value for each step.

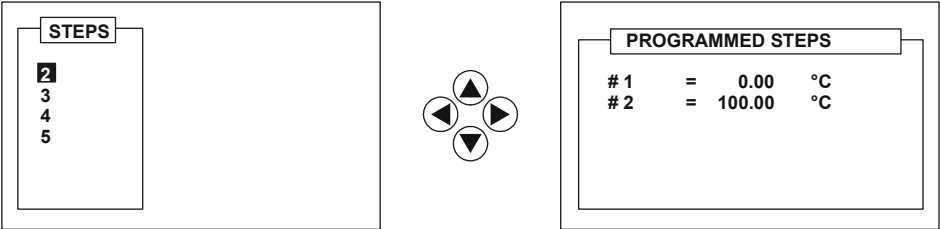

At the end of this operation, press **ent** to activate the standard working screen. Use the ▲▼ keys to increase/decrease the step value as described above for the fixed step capability.

- **Ramp mode**

The DBC series can generate temperature using programmable temperature ramp function. To set-up a ramp function from a Direct or Step working screen, press the **#** and **0** keys. The next display allows set-up of the ramp temperature limits and the required temperature gradient ($^{\circ}\text{C}/\text{minute}$), to be used during the generation (maximum capability $10.0^{\circ}\text{C}/\text{minute}$).

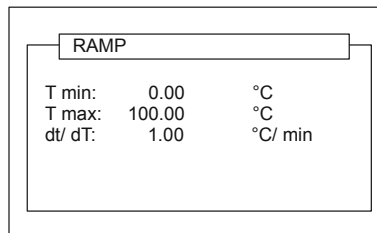

Move the cursor in vertical direction using the \blacktriangle / \blacktriangledown keys and, using the numeric keypad, set the start/finish ramp temperature values (**T min** and **T max**) and the required rate of change for the regulator. Pressing the **ent** key causes the working screen to be activated. Use the \blacktriangle key to start ramp generation, starting at the actual dry well temperature and finishing at the **T max** value. Use the \blacktriangledown key to start a negative ramp function (actual dry well temperature to **T min**). The display shows the ramp direction, together with a corresponding heating/cooling symbol.

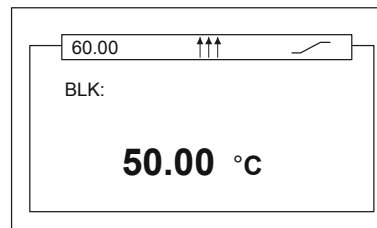

To stop the ramp, press the \blacktriangleright key. Press the \blacktriangle / \blacktriangledown keys to restart. The status bar shows the \curvearrowright ramp symbol, the temperature set-point, the $\uparrow\uparrow\downarrow\downarrow$ symbols and a **HOLD** message (if the ramp has been stopped).

- **Preset values mode**

To set-up temperature generation from the standard working screen, using **PRESET** values, the user must assign a temperature set-point value to a specific numeric key on the key-pad. From the Direct/Step/Ramp working screen, press **ce** since the setting menu is already open. Select **PRESET** using the \blacktriangle / \blacktriangledown keys and press **ent**.

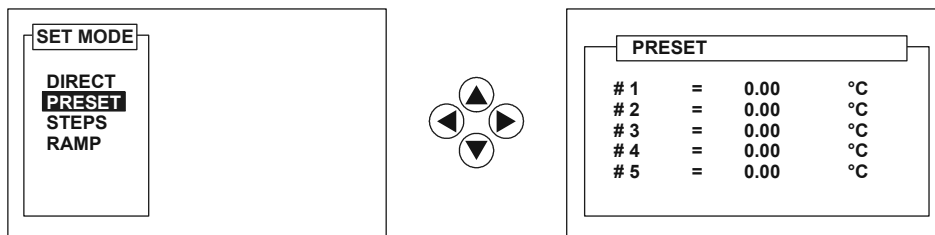

The next display allows a specific temperature value to be assigned to each of the numeric keys (1 to 5) of the key-pad. Use the \blacktriangle / \blacktriangledown keys and the numeric key-pad to set the values. Press **ent** to leave the set-up display and to open the working screen.

Pressing the **#** key followed by one of the numeric keys **1- 5** recalls the set-point assigned to the numeric key.

Note:

*Ramp, Step and Preset functions can also be set starting from the Menu Selection Screen. In an active standard working screen, press the **menu** key to open the Menu Selection Screen and use the \blacktriangle / \blacktriangledown keys to select the required temperature reference from the **REF. T** display (see next section), and press **ent**. The following screen allows set-up of the Ramp, Step and Preset parameters.*

3.7 Measuring an Input

The DBC series has a dual display. By selecting a measurement (input) option from the menu using the \blacktriangle \blacktriangledown keys and pressing **ent**, the working screen shows a dual display with the dry well temperature (at the bottom) and the selected input (at the top).

Note:

Leaving the **MEASURE** section of the Menu Selection Screen to **NONE**, the final working screen shows only the dry well temperature (with internal or external reference).

To show the dry well temperature and a thermocouple input (DBC-TC only):

- Select from the menu screen **REF .T** and then **INTERNAL**.
- Using the \blacktriangle \blacktriangledown keys, select from the menu screen **MEASURE** and then **T/C**.
- Press the **ent** key, to confirm and set the display.

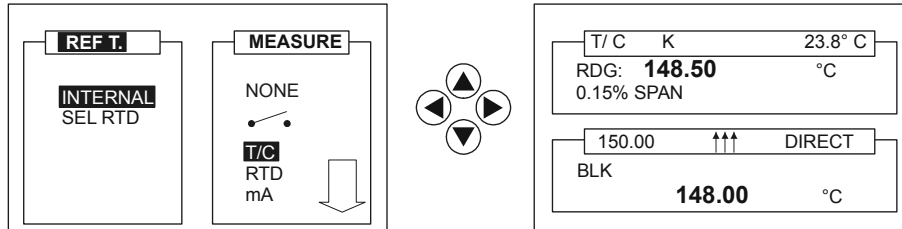

- **Switch Test**

A switch test can be carried out by connecting the device under test to the electrical connections on the top side of the instrument (identified with the \bullet symbol).

- Select from the menu screen **REF .T** and then **INTERNAL**.
- Using the \blacktriangle \blacktriangledown keys, select from the menu screen **MEASURE** and then \bullet .
- Press the **ent** key, to confirm and set the display.

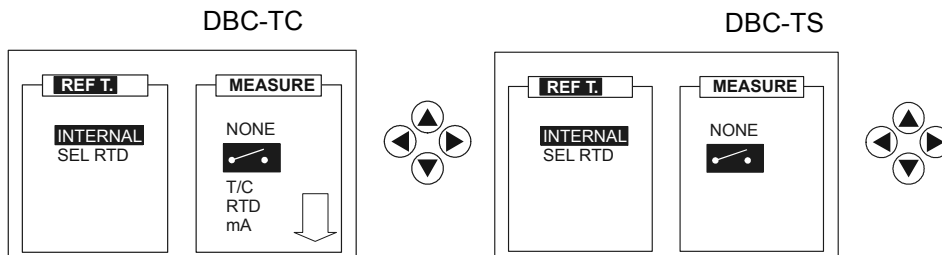

Selecting the Direct, Step or Preset generation mode, the final working screen shows the dry well temperature at the bottom (together with the temperature set-point, the generation mode and the status arrow symbol) and the contact state at the top (open/close). An audio signal indicates the change of state.

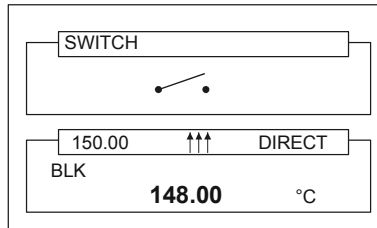

To enable the Switch Test with the indication of open, close and calculated hysteresis values, the Ramp generation mode must first be selected.

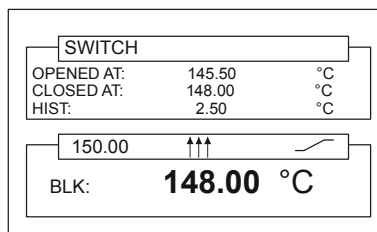

The switch test function can be rapidly recalled from any working screen by pressing the # and +/- keys. Press these keys again to disable Switch Test and to recall only the dry well temperature measurement.

- **Thermocouple Testing**

The DBC-TC series can measure the T/C electrical output, directly displaying the value in the selected temperature units.

From the Menu Selection Screen, select the required dry well temperature reference into the **REF. T** display, move the selection cursor on the **MEASURE** section using the keys, select **T/C** using the ▲▼ keys and press **ent**.

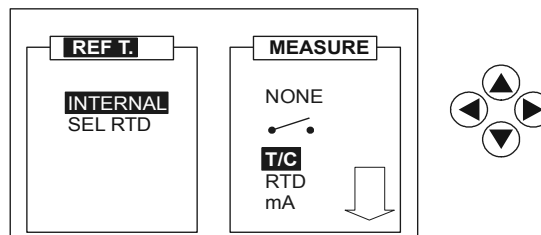

After the SET MODE selection, a new display allows the T/C type definition.

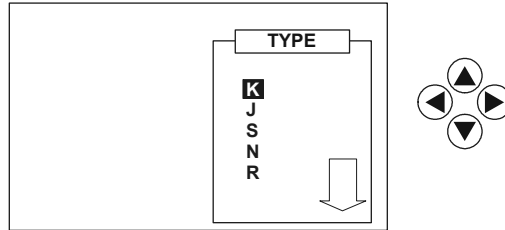

Using the \blacktriangle / \blacktriangledown keys, select the type of probe to be measured and press **ent** : the next display sets the compensation method for the T/C cold junction.

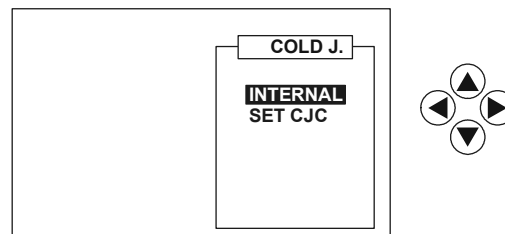

- **Internal**

This selection activates the internal CJ compensation mode. A temperature sensor fitted near the T/C electrical connection measures the CJ temperature and activates the compensation circuit.

- **Setting Cold Junction Compensation**

This sets the CJ compensation temperature reference to a programmable value between 0 to 70° C. The T/C reference table uses a CJ temperature of 0° C.

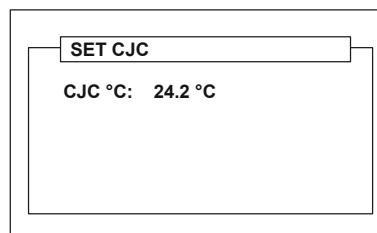

Using the \blacktriangle / \blacktriangledown keys, select the required CJ compensation method and press **ent**. The display shows the mode settings (i.e. how the T/C measurement can be displayed).

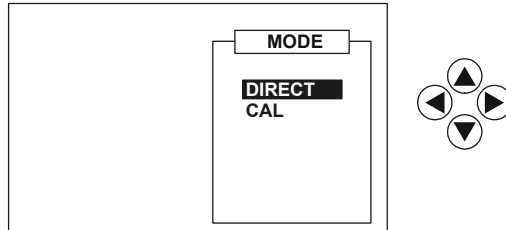

- **Direct**

This screen shows, in the top, a direct reading in the selected temperature unit, together with the T/C type and the CJ temperature. The bottom part of the screen shows, the generated temperature value (with internal or external reference), the temperature set-point, the status arrows symbols and the selected generation mode.

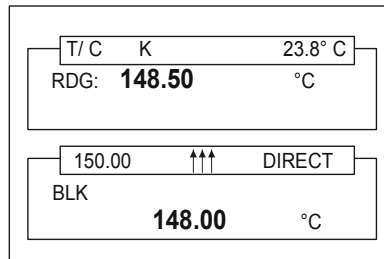

- **CAL Mode**

This facility performs an error calculation analysis for the unit under test. From the **MODE** display select **CAL** using the \blacktriangle / \blacktriangledown and press **ent**. The next display provides the setting of T/C span.

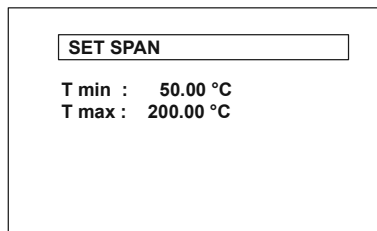

Using the \blacktriangle / \blacktriangledown select the **T min** value and set the temperature limit using the numeric key-pad: then, move the cursor on the **T max** value using the \blacktriangle / \blacktriangledown key, set the related temperature value and press **ent** to confirm. Press **ent** again to show the next display, where the error calculation method can be set.

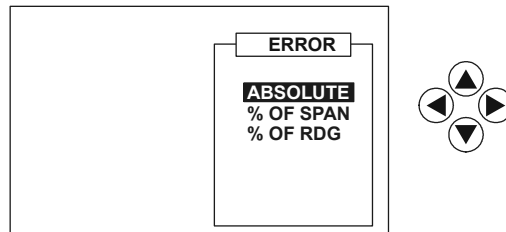

Using the keys, select the required error calculation method and press **ent**.

- **Absolute**

The display shows the error calculation as deviation in temperature measurement units between the reference temperature (internal or external) and the unit under test measurement.

- **% of Span**

This selection gives an error calculation referenced to the full-scale value.

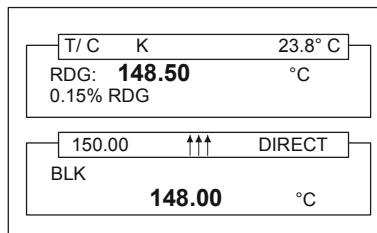

The working screen shows, in the top part, the selected T/C type, the probe measure directly in the selected temperature unit, the CJ temperature and the error value.

The bottom part of the screen shows, the generated temperature value (with internal or external reference), the temperature set-point, the status arrows symbols and the selected generation mode.

- **% of Reading**

This selection gives an error calculation referenced to a previously set, specific measuring point of the temperature span.

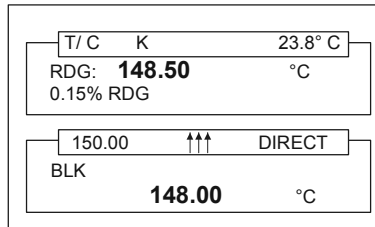

The screen shows, in the top part, the selected T/C type, the probe measure directly in the selected temperature unit, the CJ temperature and the error value.

The bottom part of the screen shows, the generated temperature value (with internal or external reference), the temperature set-point, the status arrows symbols and the selected generation mode.

- **RTD Measurements**

The DBC-TC series can measure the electrical output of RTD, displaying the value directly in the selected temperature unit.

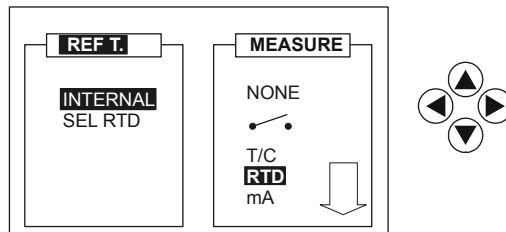

From the Menu Selection Screen, using the ▲▼ select **RTD** and press **ent**. After selection of the generation mode, a new display shows the RTD types that can be measured.

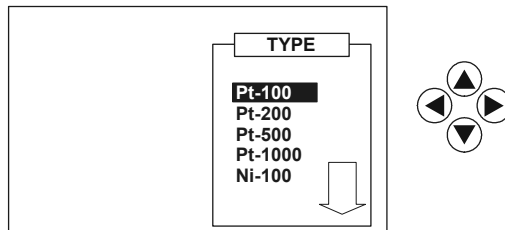

Using the ▲▼ keys to select the required **RTD** type and press **ent**. After this operation, a new display sets the connection configuration (3 or 4 wires) of the probe under test.

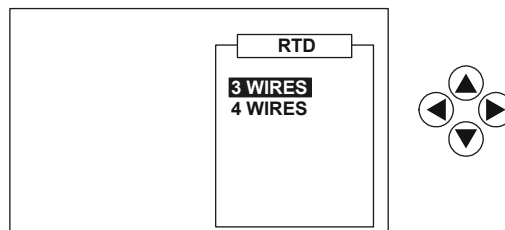

Using the ▲▼ keys, select the required connection configuration and press **ent**.

The display shows the mode settings (i.e. how the RTD measurement can be displayed).

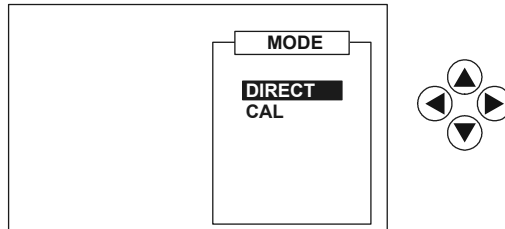

- **Direct**

This screen shows, in the top, a direct reading in the selected temperature unit, together with the RTD type and the temperature. The bottom part of the screen shows, the generated temperature value (with internal or external reference), the temperature set-point, the status arrows symbols and the selected generation mode.

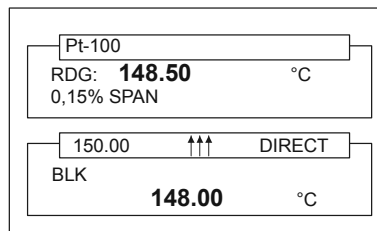

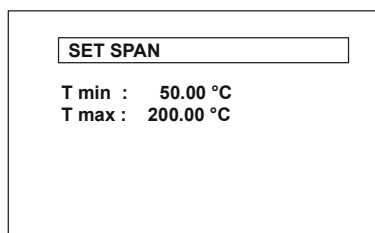

- **CAL Mode**

This facility performs an error calculation analysis for the unit under test. From the **MODE** display select **CAL** using the \blacktriangle / \blacktriangledown and press **ent**. The next display provides the setting of RTD span.

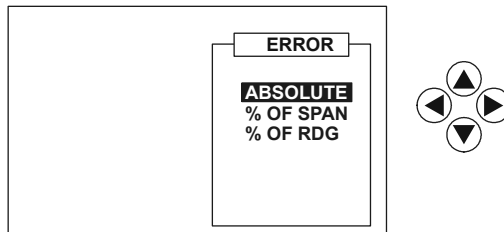

Using the \blacktriangle / \blacktriangledown select the **T min** value and set the temperature limit using the numeric key-pad: then, move the cursor on the **T max** value using the \blacktriangle / \blacktriangledown key, set the related temperature value and press **ent** to confirm. Press **ent** again to show the next display, where the error calculation method can be set.



Using the   keys, select the required method and press **ent**.

- **Absolute**

The display shows the error calculation as deviation in temperature measurement units between the reference temperature (internal or external) and the unit under test measurement.

- **% of Span**

This selection gives an error calculation referenced to the full-scale value.

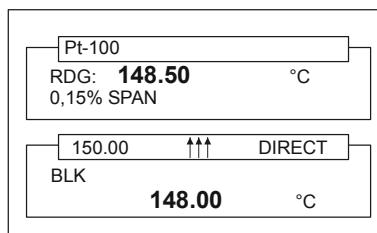

The screen shows, in the top part, the selected RTD type, the probe measure directly in the selected temperature unit and the error value.

The bottom part of the screen shows, the generated temperature value (with internal or external reference), the temperature set-point, the status arrows symbols and the selected generation mode.

- **% of Reading**

This selection gives an error calculation referenced to a previously set, specific measuring point of the temperature span.

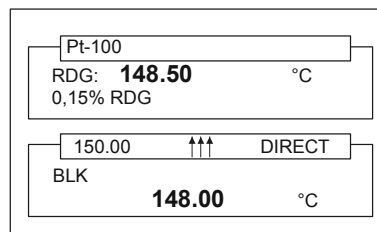

The screen shows, in the top part, the selected RTD type, the probe measure directly in the selected temperature unit and the error value.

The bottom part of the screen shows, the generated temperature value (with internal or external reference), the temperature set-point, the status arrows symbols and the selected generation mode.

Current Measurements

The DBC-TC series has an input section for direct measurement of mA signal, for example, from a DIN temperature transmitter, directly fitted on the probe under test.

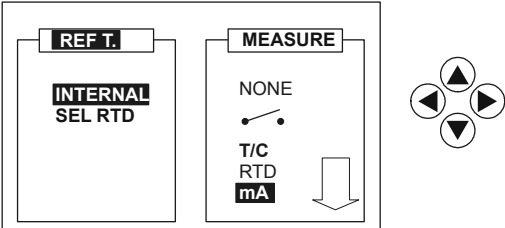

From the Menu Selection Screen, select mA using the \blacktriangle / \blacktriangledown and press **ent**. After selection of the required generation mode (DIRECT, PRESET, STEP, RAMP), the measure MODE display will be immediately recalled, allowing solution of how the mA measurement must be carried out.

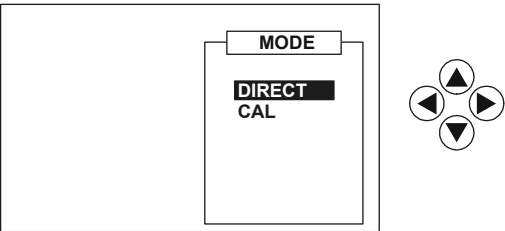

- **Direct**

Use the \blacktriangle / \blacktriangledown keys and pressing **ent**, changes the display to the working screen. The top part of the working screen shows the mA electrical signal from the device under test (i.e. a temperature transmitter) and the bottom part, the usual generated temperature parameters.

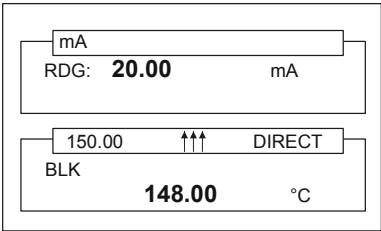

- **CAL**

Use the ▲▼ keys and pressing **ent**, changes the display. The new display allows the setting of a temperature range to the specific mA output of the device under test.

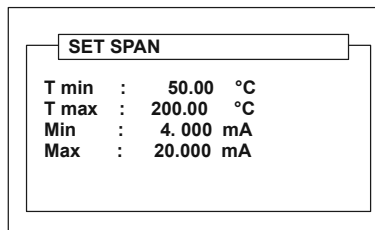

Using the ▲▼ keys to move the cursor through this display and, using the numeric key-pad, set a low temperature limit (**T min**) corresponding to a low input current limit (**Min**) and a high temperature limit (**T max**) corresponding to the high input current limit (**Max**) and press **ent** to confirm the selection and to go to the next display where the error calculation method can be set, as previously described. Selecting **ABSOLUTE**, the final working screen shows, in the top part, the mA signal from the unit under test, scaled into the selected temperature unit with the error indication reported as deviation in temperature. Selecting **% OF SPAN** or **% OF RDG** the display shows the error as a percentage value of full-scale or as a percentage value of specific reading point.

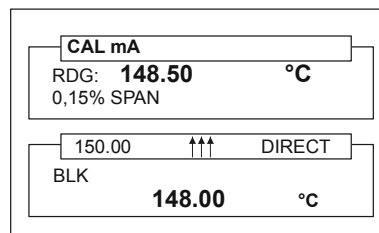

Voltage Measurements (high level)

The DBC-TC series can measure a voltage signal from temperature transmitters under test.

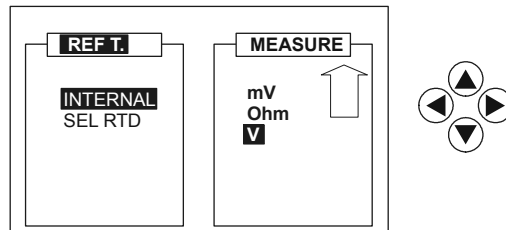

From the Menu Selection Screen, select **V** in the **MEASURE** section using the \blacktriangle / \blacktriangledown keys and press **ent**. After selection of the temperature generation mode to be used, the next display allows set-up of the voltage measurement method.

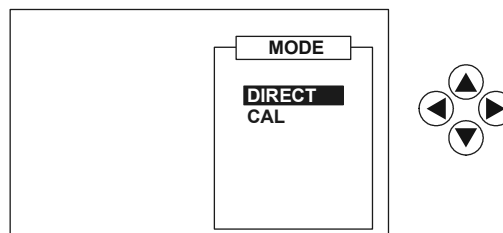

- **Direct**

Use the \blacktriangle / \blacktriangledown keys and pressing **ent**, changes the display to the working screen. The top part of the working screen shows the voltage signal from the unit under test in the top part and the parameters of the generated temperature in the bottom part.

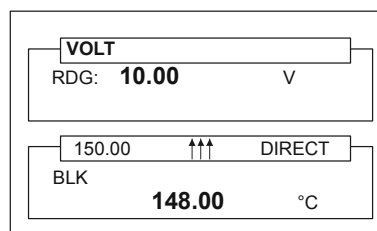

- **CAL**

Use the \blacktriangle \blacktriangledown keys and pressing **ent**, changes the display. The new display allows the setting of a temperature range to the specific voltage output of the device under test.

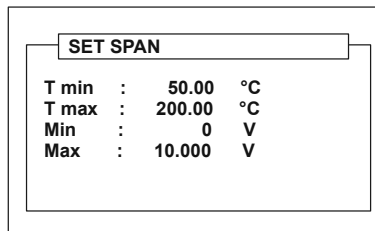

Using the \blacktriangle \blacktriangledown keys, move the cursor through this display and set the values with the numeric key-pad: **T min** value is the low limit for the UUT temperature range, related to its low limit output voltage, **T max** is the full-scale for the UUT temperature range, related to the high limit of its output voltage. Press **ent** to confirm and to go to the next display, where the error calculation mode can be set.

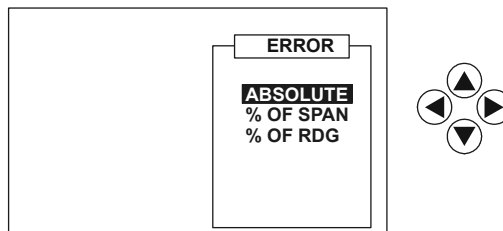

Using the \blacktriangle \blacktriangledown keys, select **ABSOLUTE** and press **ent**: the final working screen shows the generated temperature parameters in the bottom part of the display, and the voltage measurement scaled into the selected temperature unit in the top part. The error (deviation) calculation is shown with small digit between the two sections of the display and with a temperature unit value.

If in the **ERROR** screen, using the \blacktriangle \blacktriangledown keys, the **% OF SPAN** or **% OF RDG** functions are selected, pressing the **ent** key, the final working screen shows the error calculation as a percentage deviation related to the full-scale of the device under test temperature range or to its specific measuring point.

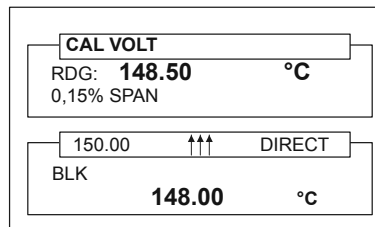

Voltage Measurements (low level)

The DBC-TC series can measure the low level signal from a thermocouple device under test: using this capability, the operator can make a direct verification of the electrical behaviour for the T/C under test.

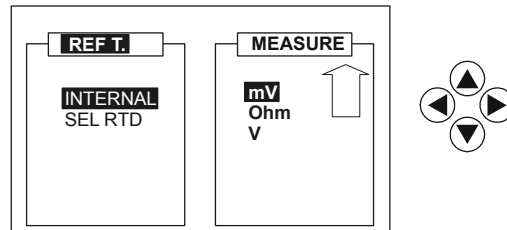

From the Menu Selection Screen, select **mV** using the \blacktriangle \blacktriangledown keys and press **ent**. After the usual selection of the temperature generation mode to be used (Direct, Ramp, Preset or Step), the final working screen will be immediately recalled showing the generated temperature parameters in the bottom part of the display and the measured millivolt value in the top part of it.

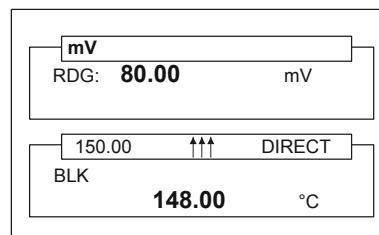

Resistance Measurement

The DBC-TC series can directly measure the resistance value of an RTD under test.

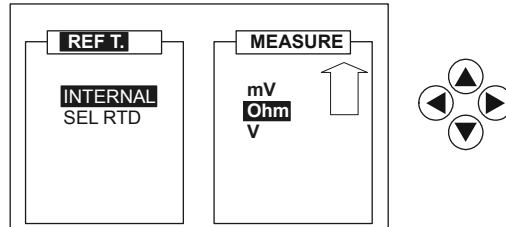

From the Menu Selection Screen, select **Ohm** in the **MEASURE** section using the \blacktriangle / \blacktriangledown keys and press **ent**. After selection of the temperature generation mode, the next display sets the connected RTD as a 3 or 4 wire device.

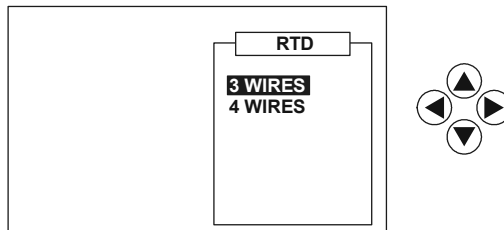

Using the \blacktriangle / \blacktriangledown select the required connection and press **ent**. The final working screen shows the generated temperature in the lower part of the display and the measured Ohmic value in the top part.

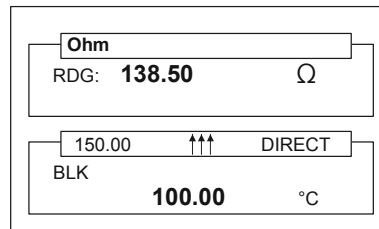

4 SERIAL COMMUNICATION

Using the standard digital RS232 interface, the calibrator can be controlled from a remote computer. By sending commands via the RS232 interface, the calibrator automatically retrieves temperature readings or modifies any parameter settings (temperature set-point, temperature reference selection, ramp/step/preset generation etc.).

4.1 DBC Series - Serial Commands Protocol

ABBREVIATIONS:

aa:	Two digit DBC address in ASCII format. (i.e.. 01). Send 00 to overwrite every other address.
par:	Parameter. Command depending format.
R/W:	Read and Write command
R:	Read Only command
n.a.:	Not Applicable
[]:	Every parameter enclosed in square bracket are optional

Command Flow	Command	Parameters	Description	Model (TS/TC)
Write	*aaEM=par	Par = 0 Absolute error °C	R/W - Error Computation Mode	TC
Read	*aaEM?	1% of span	(MM command to set CAL mode)	TC
Query	!aaEM=par	2% of readings		TC
Write	n.a.	Par = floating point	R – Get Error Value	TC
Read	*aaER?		(Mode selected by EM command)	
Query	!aaER=par			
Write	*aaICc=par	c =1 Regulator (optional)	R/W –Input Channel	TS
Read	*aaICc?	2 Measure		TC
Query	!aaICc=par	par = 0 NONE	No measure	TS
		1 n.a.		
		2 T/C +CJ	Thermocouple + Cold Junction	TC
		3 T/C no CJ	Thermocouple without Cold Junct.	TC
		4 RTD 3 Wires	Thermoresistors 3 wires	TS/TC
		5 RTD 4 Wires	Thermoresistors 4 wires	TS/TC
		6 RES 3 Wires	Resistors up to 400 Ω 3 wires	TC
		7 RES 4 Wires	Resistors up to 400 Ω 4 wires	TC
		8 mV	mV input	TC
		9 n.a.		
		10 n.a.		
		11 n.a.		
		12 mA	mA input	TC
		13 n.a.		
		14 Switch	Switch mode	TS/TC
		15 n.a.		
		16 n.a.		TS/TC
		17 Reference RTD 4 wires	User Thermoresistors 4 wires	TS/TC
		18 V	Volt Input	TC

Command Flow	Command	Parameters	Description	Model (TS/ TC)
Write Read Query	n.a. *aaIRc? !aaIRc= par	c = 1 Reference RTD 2 Measure par = floating point value	R – Get Input Measure value	TS/TC TC
Write Read Query	*aaISc=par *aaISc? !aaISc=par	c = 1 Reference RTD 2 Measure par = 0 NONE 10 PT100 IEC 11 PT200 IEC 12 PT500 IEC 13 PT1000 IEC 16 Ni100 DIN 19 Reference RTD 20 T/C B IEC 21 T/C E IEC 22 T/C J IEC 23 T/C K IEC 24 T/C N IEC 25 T/C R IEC 26 T/C S IEC 27 T/C T IEC 28 T/C U DIN 29 T/C L DIN 30 T/C C	R/W –Sensor type No sensor	TS/ TC TC TS/TC TS/TC TC TC TC TC TC TC TC TC TC TC TC TC TC TC TC TC TC TC TC
Write Read Query	*aaCJ[1]=par *aaCJ[1]? !aaCJ[1]=par	par = Floating Point	R/W –Manual Cold Junction Value (Value in current Temperature Units)	TC
Write Read Query	*aaIUc=par *aaIUc ? !aaIUc=par	c = 1 Reference RTD 2 Measure par =98 NONE 80 °F 81 °C 82 °K 60 mA 61 V 62 mV 63 Ω	R/W –Input Units Unit n.a Fahrenheit Celsius Kelvin Milliampere Volts Millivolts Ohms	TS/ TC TC TS/ TC TS/ TC TS/ TC TC TC TC TC TC TC TC TC
Write Read Query	*aaKB[1]=par *aaKB[1]? !aaKB[1]=par	par = 0 silent keyboard 1 beep on	R/W –Keyboard bid	TS/ TC

Command Flow	Command	Parameters	Description	Model (TS/TC)
Write Read Query	*aaKM[1]= par *aaKM[1]? !aaKM[1]= par	par = 0 keys disabled 1 keys enabled	R/ W – Local lockout keyboard	TS/TC
Write Read Query	*aaMRc= par *aaMRc? !aaMRc= par	c = 1 zero scale 2 full-scale par = floating point value	R/ W – Measure Range (mA or V in CAL ERROR mode)	TC TC
Write Read Query	*aaMM= par *aaMM? !aaMM= par	par = 0 Direct mode 1 Cal mode	R/ W – Measurement mode	TC TC
Write Read Query	*aaOM[1]= par *aaOM[1]? !aaOM[1]= par	par = 0 Direct mode 1 Preset mode 2 Steps mode 3 Ramp mode	R/ W – Output mode	TS/TC TS/TC TS/TC TS/TC
Write Read Query	*aaOP[1]= par *aaOP[1]? !aaOP[1]= par	par = floating point value	R/ W – Point Temperature	TS/TC
Write Read Query	n. a. *aaOR[1]? !aaOR[1]= par		R – Read Controlled Temperature	TS/TC
Write Read Query	*aaPB[1]= par *aaPB[1]? !aaPB[1]= par	par = 0 to 99.9 floating point value	R/ W – Proportional band	TS/TC
Write Read Query	*aaPSc= par *aaPSc? !aaPSc= par	par = floating point value c = 1 preset step #1 2 preset step #2 3 preset step #3 4 preset step #4 5 preset step #5	R/ W – Preset Set Values	TS/TC TS/TC TS/TC TS/TC TS TC
Write Read Query	*aaRlc? !aaRlc= par	c = 1 Model 2 Software Version	R – Read Model and Software Version.	TS/TC
Write Read Query	*aaRM[1]= par *aaRM[1]? !aaRM[1]= par	par = 0 Ramp Down 1 Ramp Up 2 Down Hold 3 Up Hold	R/ W – Ramp mode	TS/TC

Command Flow	Command	Parameters	Description	Model (TS/TC)
Write Read Query	*aaRRc= par *aaRRc? !aaRRc= par	par = floating point c = 1 zero scale 2 full-scale	R/W – Ramp Range	TS/TC
Write Read Query	*aaRS[1]= par *aaRS[1]? !aaRS[1]= par	par r = floating point	R/W – Ramp Slope	TS/TC
Write Read Query	*aaSA[1]= par *aaSA[1]? !aaSA[1]= par	par = 1 to 99	R/W – Station Address	TS/TC
Write Read Query	*aaSL[1]= par *aaSL[1]? !aaSL[1]= par	par = 0 ENGLISH 1 FRENCH 2 GERMAN 3 ITALIAN 4 PORTUGUESE 5 SPANISH	R/W – Language	TS/TC
Write Read Query	n.a. *aaSN[1]? !aaSN[1]= par	par = 1 to 65535	R – Serial Number	TS/TC
Write Read Query	*aaSP[1]= par *aaSP[1]? !aaSP[1]= par	par = 1 to 5 - # of step	R/W – Number of preset step	TS/TC
Write Read Query	*aaSWc= par *aaSWc? !aaSWc= par	par = floating point c = 1 – Opened 2 – Closed 3 - Hysteresis	R – Switch test threshold	TS/TC
Write Read Query	*aaTD[1]= par *aaTD[1]? !aaTD[1]= par	par = 1 to 255	R/W – Derivative constant	TS/TC
Write Read Query	*aaTI[1]= par *aaTI[1]? !aaTI[1]= par	par = 1 to 255	R/W – Integration constant	TS/TC
Write Read Query	*aaTU[1]= par *aaTU[1]? !aaTU[1]= par	par = 80 °F 81 °C 82 °K	R/W – Temperature units	TS/TC
Write Read Query	*aaTRc= par *aaTRc? !aaTRc= par	par = floating point value c = 1 low scale 2 full-scale	R/ W – Temperature Range (CAL ERROR mode)	TC

Command Flow	Command	Parameters	Description	Model (TS/TC)
Write Read Query	n. a. *aa. Ac? !aa. Ac= par	par = floating point c = 1 regulator channel 2 n. a. 3 calibrator board	R – Get cold junctions compensation	TS/TC
Write Read Query	n. a. *aa. Mc? !aa. Mc= par	par = Exp. floating point c = 1 regulator temp. 2 REF Probe temp. 3 calibrator value	R – Not averaged measures (diagnostic purposes)	TS/TC
Write Read Query	n. a. *aa. Pc? !aa. Pc= par	par = Exp. floating point c = 1 reg. Sensor mV out 2 REF sensor mV out 3 Cal. Electrical value.	R – Main measures (diagnostic purposes)	TS/TC
Write Read Query	*aaRN = par *aaRN? !aaRN = par	par = integer 0 = REF 1 1 = REF 2	Reference RTD selection	TS/TC
Write Read Query	n.a. *aaST? !aaST = par	par = integer 0 = Cooling 1 = Heating 2 = Ready	Status of controller	TS/TC
Write Read Query	*aaCN = par *aaCN? !aaCN = par	par = integer 0 = 10% 1 = 30% 2 = 50% 3 = 70% 4 = 90% 5 = 100%	Select display contrast	TS/TC
Write Read Query	*aaURc = par *aaURc? !aaURc = par	par = floating c = 1 REF 1 c = 2 REF 2	Ref probe R0 coefficient	TS/TC
Write Read Query	*aaUAc = par *aaUAc? !aaUAc = par	par = floating c = 1 REF 1 c = 2 REF 2	Ref probe A coefficient	TS/TC
Write Read Query	*aaUBc = par *aaUBc? !aaUBc = par	par = floating c = 1 REF 1 c = 2 REF 2	Ref probe B coefficient	TS/TC
Write Read Query	*aaUCc = par *aaUCc? !aaUCc = par	par = floating c = 1 REF 1 c = 2 REF 2	Ref probe C coefficient	TS/TC
Write Read Query	*aa. Tc *aa. Tc? !aa. Tc= par	par = integer c = 1 REF 1 c = 2 REF 2	Ref probe tag number	TS/TC

5 CALIBRATION

The DBC series of temperature calibrators must be considered as reference standard: these instruments must be periodically tested and calibrated with a recommended recalibration period of 12 months. The Service Centres of GE provide a global calibration service to National and International standards.

Calibration must be carried out by the suitably qualified calibration technicians. The calibration procedure requires a high-accuracy reference standard (at least 5 times better than the DBC accuracy) with direct traceability to National or International Standard (SIT, UKAS etc.).

Press the # and the **menu** keys to select the set-up display.

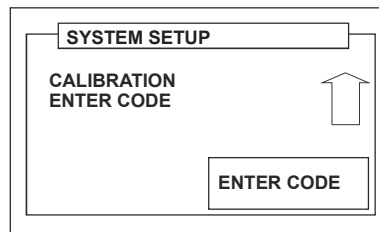

Use the ▲▼ keys to select **CALIBRATION** and press **ent**.

Important Note

A PIN code protects the calibration facility from unauthorised use. Each instrument, on delivery, contains the factory set PIN (4321). To continue protecting the calibration facility, the PIN code should be changed as soon as possible.

Enter the correct PIN at the **ENTER CODE** prompt and press **ent**. After entering the PIN number, calibrate the instrument by following the on-screen instructions.

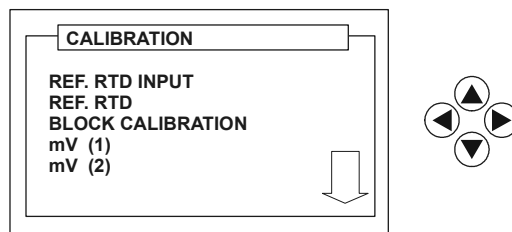

- **Calibration of the standard Reference Probe Input**

In the calibration menu, using the cursor keys select the **REF. RTD INPUT** and press **ent**. The display enables the setting of the resistance test value (true value).

Using a decade resistance box, generate the required value (to the Ref. Probe connection on the electrical panel) and press **ent**. The microprocessor combines the two values automatically. The nominal value is the value recommended for the test.

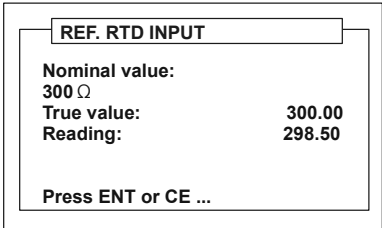

- Calibration of the external Reference Probe (DBC-TS and DBC-TC)**
 By selecting the **REF RTD** from the calibration menu and pressing **ent**, a new display opens to set all the parameters needed for the connected Reference RTD (Tag number, R0 values, coefficients).

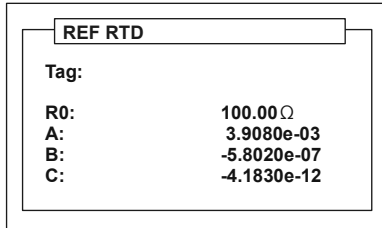

Move the cursor with the **▲▼** keys and set the value with the numeric key-pad. In this way, a characterisation of the specific Reference Probe can be made. Press **ent** to return to the calibration menu.

- Calibration of the internal dry well Sensor (DBC-TS and DBC-TC)**
Note: Starting this procedure after at least 1 hour of warm-up, achieves a better accuracy.

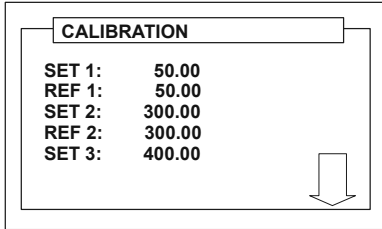

- 1 To calibrate the dry well regulation, install a suitable reference probe in the dry well and connect it to the Reference Probe socket in the front panel.
- 2 Follow the above procedure to insert the coefficients of the probe in use.
- 3 Change from **INTERNAL** to **SEL RTD**, Direct mode. The display shows the temperature measured by the Reference Probe.
- 4 Select the **CALIBRATION** menu and use the PIN to enter the menu. Record the values of SET1 ...SET4, and REF1 ... REF4.
- 5 Set the dry well temperature at SET1 value; wait at least 30 minutes at this temperature. Record the true temperature value on display, identify this value as READ1.
- 6 Set the dry well temperature at SET2 value; wait at least 30 minutes at this temperature. Record the true temperature value on display, identify this value as READ2. Repeat this procedure for SET3 and SET4 and record values READ3 and READ4.
- 7 Enter the Calibration menu, select dry well CALIBRATION.
- 8 Calculate the NEWREF1 ... NEWREF4 value as follow: $NEWREFx = READx - SETx + REFx$.
- 9 Type in REF1 ...REF4 fields the values NEWREF1 ...NEWREF4.
- 10 Press ENTER. DBC650 (150) automatically calculates the coefficients.
- 11 The calibration of the dry well temperature regulator has been completed.

- **Calibration of the millivolt input ranges (DBC-TC only)**

The DBC-TC series has four different millivolt input ranges to be calibrated, depending on the type of thermocouple measurements available, the calibration procedure is the same.

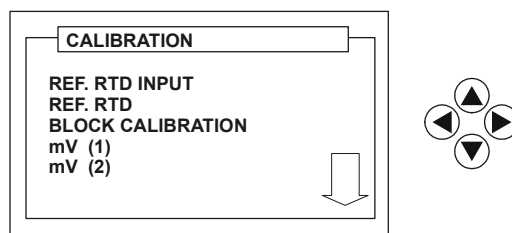

From the CALIBRATION menu select one of the mV input range to be calibrated using the ▲▼ and press **ent**.

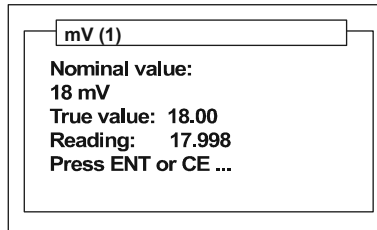

Using a certified and high accuracy millivolt simulator, generate a millivolt signal to the T/C electrical connection on the front panel (nominal value is the recommended value for the calibration): pressing the **ent** key causes the microprocessor to combine the millivolt values (true value and effective reading).

- **Calibration of the Volt input range (DBC-TC only)**

From the CALIBRATION display, select **V INPUT** using the \blacktriangle \blacktriangledown keys and press **ent**.

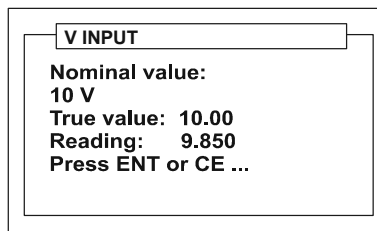

Using a certified and high accuracy Volt simulator, apply the calibration signal to the Voltage electrical connection on the front panel of the instrument (the nominal value is the recommended value for the test).

Pressing the **ent** key causes the microprocessor to combine the voltages indication (True value and Reading).

- **Calibration of the mA input range (DBC-TC only)**

From the **CALIBRATION** display, select **mA INPUT** using the \blacktriangle \blacktriangledown keys and press **ent**.

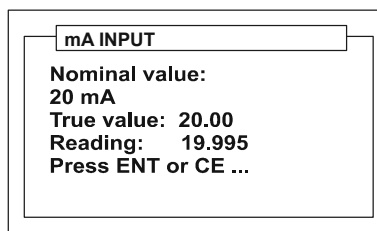

Using a traceable and high accuracy mA simulator, generate a specific current value to the related electrical connection on the front panel of the instrument (the

Nominal Value is the recommended value for the test): pressing the **ent** key causes the microprocessor to combine the current indications on the display (True Value and Effective Reading).

- **Calibration of the resistance (Ohm) input ranges (DBC-TC only)**

As for the millivolt input range, also the resistance measurement channel has different ranges capability, depending on the RTD measurement available.

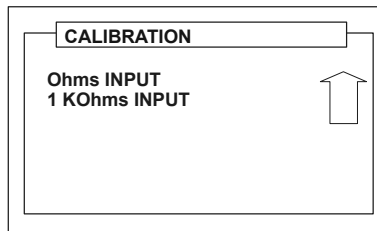

From the CALIBRATION menu select the required Ohms input range to be calibrated, using the ▲▼ keys, and press **ent**.

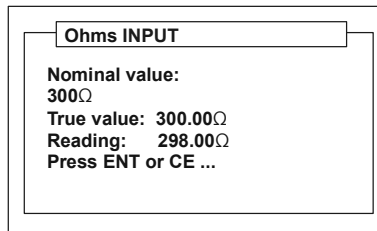

Using a certified and high accuracy Ohms simulator, apply the required value to the related electrical connection on the front panel of the instrument (the nominal value is the recommended value for the test).

Pressing the **ent** key causes the microprocessor to combine the resistance measure on the display (true value and effective reading).

6 FAULT FINDING

	Fault description	Possible problem	Solution
1.	The instrument does not work even if the power cord is correctly fitted and the mains switch is in the correct position.	- faulty protection fuse - faulty power cable - faulty power switch	-Replace the fuse -Replace the power cable -Contact your service representative
2.	When the instrument is turned on the fuse blows	- short circuit on power supply card - faulty power switch	-Contact your service representative
3.	The heating and cooling function of the dry well is not working	- faulty power supply card - faulty controller card - damage to one or more Peltier cells	-Contact your service representative
4.	The controller is not disabled when the set-point is reached	- faulty controller card	-Contact your service representative
5.	The heating and cooling times out of specification.	-damage to one or more Peltier cells or -damage to the heating system	-Contact your service representative
6.	Fan system not working.	-faulty power supply card -faulty controller card -faulty fan	-Contact your service representative
7.	At high temperatures the instrument cannot stabilize.	-incorrect step or preset values -faulty reference probe	-Change the step or preset values -Contact your service representative

Note:

Fuses are designed to give maximum protection in case of fault. Make sure that voltage selector and fuses are selected for the nominal working value.

7 MAINTENANCE

7.1 CLEANING INSTRUCTIONS

- 1 Wait until the instrument is at ambient temperature before cleaning.
- 2 Disconnect the instrument from the power supply and clean the keyboard and case with a damp cloth, using a little mild detergent.

CAUTION:

DO NOT, under any circumstances, use any form of solvent for cleaning purposes. Using solvent damages the case.

8 TECHNICAL SPECIFICATION

8.1 Standard Specification

	DBC 150-TC and TS	DBC 650-TC and TS
Temperature range	-45°C (from ambient) to +150°C	50°C to 650°C
Well depth	dry well 160mm (6.3in) insertion depth 155mm (6.1in)	dry well 160mm (6.3in) insertion depth 155mm (6.1in)
Well diameter	30mm (1.18in)	30mm (1.18in)
Stability	0.03°C	0.05°C (between 70° and 650°C) 0.15°C (between 50° and 70°C)
Radial Uniformity (adjacent holes)	0.15°C	0.25°C
Heating time	14 minutes (20°C to 120°C)	22 minutes (25°C to 650°C)
Cooling time	22 minutes (25°C to -20°C)	27 minutes (600°C to 100°C with optional cooling probe)
Display resolution	0.01°C	0.01°C
CJ compensation error	0.3°C	0.3°C
Reference probe accuracy	0.2°C (including B1 probe)	0.3°C (including B2 probe)
Power supply	100-120 or 220-240 Vac, 50-60 Hz, 230 VA	100-120 or 220-240 Vac, 50-60 Hz, 1385 VA
	DBC 150 TC only	DBC 650 TC only
Maximum mA IN (current signal)	35 mA	35 mA
Maximum V IN (voltage signal)	30 Vdc	30 Vdc

8.2 Common specification

Display area	60 x 40mm (2.36 x 1.57 in) LCD with backlighting
Temperature units	°C K °F
External Ref. Probe	Facility for connection of a PT100 reference probe
Switch Test	Facility for connection of switch contacts
Communication Interface	RS232, supplied as standard
Software function	Ramp, step and preset temperature generation. Switch test
Operating temperature range	10 to 50°C
Reference Standards	PT 100 EN 60751: 1998-05 (ITS 90) EN 60584-1: 1997-10 {DBC-TC only} Thermocouples EN 60584-2: 1998-02
Conformity Standards	EMC EN 61326 (1997) + A1(1998) + A2 (2001) Safety EN 61010-1: 2001 (2nd edition)
Measurement Category	I (all measurement terminals MAX 30V to earth)
Pollution degree	2
Regulation sensor	Thermocouple
Weight	9.5 kg (21 lbs)
Dimensions	322 x 156 x 328mm (12.7 x 6 x 12.9 in)

8.2 Electrical Input Specifications

- DBC-TC models

Input	Range	Resolution	Accuracy (90 days)	Accuracy (1 year)
PT100	-99 /+750°C	0.01°C	0.04°C	0.15°C
PT200	-99 /+750°C	0.1°C	0.1°C	0.3°C
PT500	-99 /+750°C	0.1°C	0.1°C	0.3°C
PT1000	-99 /+550°C	0.1°C	0.1°C	0.3°C
Ni100	-60 /+250°C	0.01°C	0.05°C	0.15°C
T/C K	-99 /+990°C	0.1°C	0.1°C	0.3°C
T/C J	-99 /+990°C	0.1°C	0.1°C	0.3°C
T/C S	-50 /+100°C	0.1°C	0.3°C	1°C
	100 /+990°C	0.1°C	0.2°C	0.6°C
T/C N	-99 /+990°C	0.1°C	0.1°C	0.3°C
T/C R	-50 /+100°C	0.1°C	0.3°C	0.9°C
	100 /+990°C	0.1°C	0.2°C	0.6°C
T/C B	200 /+500°C	0.1°C	0.8°C	2.5°C
	500 /+990°C	0.1°C	0.5°C	1.5°C
T/C C	0 /+990°C	0.1°C	0.2°C	0.6°C
T/C E	-99 /+990°C	0.1°C	0.1°C	0.3°C
T/C T	-99 /+400°C	0.1°C	0.1°C	0.3°C
T/C L	-99 /+800°C	0.1°C	0.1°C	0.3°C
	800 /+900°C	0.1°C	0.3°C	0.9°C
T/C U	-99 /+50°C	0.1°C	0.2°C	0.6°C
	-50 /+0°C	0.1°C	0.1°C	0.3°C
	0 /+500°C	0.1°C	0.1°C	0.3°C
	500 /+600°C	0.1°C	0.3°C	0.9°C
Volts	0 /+12V	0.001V	0.01%RDG+0.01%FRO	0.03%RDG+0.03%FRO
mV	0 /+79.2mV	0.001mV	0.003%RDG+0.002%FRO	0.01%RDG+0.006%FRO
mA	0 /+24mA	0.001mA	0.005%RDG+0.005%FRO	0.015%RDG+0.015%FRO
Ohm	0 /+400Ω	0.01Ω	0.003%RDG+0.003%FRO	0.01%RDG+0.01%FRO

1. T/C and RTD accuracy includes electrical and conversion table uncertainty.
2. T/C Total accuracy not including CJ compensation.
3. RTD Total accuracy measured @ 0.2 mA excitation.

Approved service agents:
www.gesensing.com

